

James Walker[®]

'O' Ring Guide

Issue 6

The comprehensive guide to 'O' ring sealing systems including

- **'O' ring selection**
- **General & high performance materials**
- **Housing design & tolerances**
- **Cords, kits & lubricants**



High Performance Sealing Technology



'O' Ring Guide



Introduction

The 'O' ring, or toroidal seal, is an exceptionally versatile sealing device. Applications, ranging from garden hose couplings to aerospace or oil and gas duties, make it the world's most popular volume-produced seal.

'O' rings offer many benefits to designers, engineers, maintenance staff and plant operators, they:

- Suit many static and dynamic applications.
- Are very compact and occupy little space.
- Seal efficiently in both directions.
- Can work between -65°C and +325°C when made of elastomer — according to material type.
- Can function at temperatures down to -200°C when made of PTFE.

Today, the design engineer is faced with a bewildering array of 'O' ring statistics and advice. In this guide we simplify the design data, give concise information on materials and facilitate part selection for specification and ordering purposes.

'O' ring stocks & availability

We stock many thousands of types and sizes of 'O' rings in our most popular materials — including rapid gas decompression (RGD) resistant grades — ready for same day despatch.

If the rings you want are not available off-the-shelf, we can precision manufacture them within hours, if necessary. With our 'lean' manufacturing plant and flexible production schedules, we can meet industry's most urgent requests.

Quality

Standards and approvals

Our Quality System is third-party certified to the latest versions of both the Aerospace standard BS EN 9100 and to BS EN ISO 9001.

Moreover, we are regularly assessed and quality approved by a wide range of industry bodies and individual customers, including multinational corporations, utilities and government organisations. An ISO 2230 compliant package is offered as standard.

We also hold test equipment for all relevant BS, ISO, ASA, API, ANSI, DIN, DTD and NATO standards. Certificates of conformity are supplied on request.

In-house facilities include specialised equipment for rapid gas decompression (RGD) testing, including qualification to Norsok M-710 Annex B (see page 11).

Packaging and labelling is available to customers' individual specifications.

Material Safety Data Sheets (MSDS) are available for every product we supply.

'O' Ring Guide



Quality production and inspection

Our Materials Technology Centre houses one of Europe's most advanced facilities for elastomer batch production. At its heart is a computer-controlled internal mixer that holds formulae for all our elastomeric compounds — well over 300 in total.

Together with on-line rheometer testing, this gives us complete batch traceability, regardless of any release certificate requirements.

The post-curing of silicone and fluorocarbon elastomers is also under microprocessor control for temperature and time. Each cure cycle is recorded and is traceable as a vital link in our quality chain.

Every 'O' ring manufactured by James Walker is visually inspected by a dedicated human inspector, or an automated optical inspection system, to the appropriate grade requirements of BS ISO 3601-3. Each production batch of seals is further dimensionally verified using our highly accurate and reproducible optical inspection systems.

These state-of-the-art optical systems are the Micro-Vu and fully-automated Basler Vario2, both of which offer sub-micron resolution with exceptional repeatability.



Micro-Vu optical inspection system



Basler Vario2 fully-automated inspection system

Contents

	Page
How to use this guide	
Selecting an 'O' ring	4
Selecting a back-up ring	5
Selecting a material	6
How to order	7
Materials & properties	
General materials	8
High performance materials	9
Guide to material use	10
Service grades	10
Rapid gas decompression	11
FEP encapsulated 'O' rings	12
Back-up rings	12
James Walker 'O' rings	
Chart 50: inch & metric sizes	13-16
'O' rings for pipe fittings	16
Aerospace sizes to BS ISO 3601-1	17-20
Chart 72: metric sizes	21-22
Chart 17000: inch sizes	23
Non-standard sizes	24
Complementary products	
Coloured materials	25
'O' ring cord	25
Commercial quality 'O' rings	25
'O' ring kits	26
Special packaging & kits	26
'O' ring lubricants	26
General design notes	27-28
Housing design	29-31
General information	31
Contact details	32

How to use this guide



Selecting an 'O' ring

This guide contains four size charts:

- **Chart 50:** including BS 1806, SAE AS 586, and BS ISO 3601-1 (non-aerospace). *Note: BS 1806 has been superseded by BS ISO 3601-1 and BS ISO 3601-2.*
- **Aerospace sizes to BS ISO 3601-1.**
- **Chart 72:** metric sizes to BS 4518.
- **Chart 17000:** James Walker inch sizes.

To match an existing 'O' ring

If your existing 'O' ring has a reference of BS 1806, BS ISO 3601-1, SAE AS 568, or BS 4518:

- 1) Refer to **Chart 50** for BS 1806, BS ISO 3601-1 (non-aerospace), and SAE AS568. Then quote appropriate James Walker number.
- 2) Refer to **Aerospace Sizes to BS ISO 3601-1** for rings to this aerospace standard. Then quote the appropriate size code.
- 3) Refer to **Chart 72** for BS 4518. Then quote the appropriate James Walker number.

If you have a **JW Chart 17000** reference for an 'O' ring, please quote that number.

Diameter sections 'A' used in charts

Chart 50 (BS 1806, BS ISO 3601-1, SAE AS 568)	Aerospace sizes to BS ISO 3601-1	Chart 72 (BS 4518)	Chart 17000
0.070" 1.78mm	0.071" 1.80mm	1.6mm	0.063"
0.103" 2.62mm	0.104" 2.65mm	2.4mm	0.094"
0.139" 3.53mm	0.140" 3.55mm	3.0mm	0.125"
0.210" 5.33mm	0.209" 5.30mm	5.7mm	0.188"
0.275" 6.99mm	0.276" 7.00mm	8.4mm	0.250"

If only the size is known

- 1) Obtain diameter section A of 'O' ring.
- 2) Consult table (above) to find the Chart that covers the appropriate diameter section A.
- 3) Consult appropriate Chart (pages 13-23), under the specific diameter section A.
- 4) Obtain inside diameter B of ring.
- 5) Refer to column on Chart that lists B and identify your existing 'O' ring.
- 6) Quote the appropriate part number.

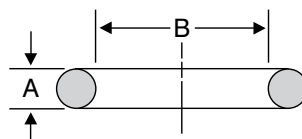

'O' ring diameter section A and inside diameter B.

If 'O' ring is a non-standard size

Please contact our Technical Support Team. We have in excess of 8000 'O' ring moulds in our library, and are certain we can help.

To fit an existing housing

- 1) Refer to diagrams on page 29.
- 2) Select the one that matches your housing.
- 3) Obtain from existing housing the critical dimensions shown on selected diagram.
- 4) Refer to housing tables on page 30. These show BS 1806/SAE AS 568 in both inch and metric units, and BS 4518 in metric with more data on pages 21-22.
- 5) Cross reference the dimensions on housing tables.
- 6) Read off diameter section A, and consult the appropriate Chart under that specific diameter section.
- 7) Refer to column that shows housing diameter (coded as selected diagram on page 29) and identify the one that matches yours.
- 8) Quote appropriate part number.

How to use this guide

**For new applications**

- 1) Refer to Design sections, pages 27-31, for guidance with regard to applications.
- 2) For aerospace equipment, select 'O' ring from **Aerospace Sizes to BS ISO 3601-1**, pages 17-20.
- 3) For general metric equipment, select 'O' ring from **Chart 72**, pages 21-22.
- 4) If the metric size you require is not available from **Chart 72**, then select from the metric columns in **Chart 50**, pages 13-16.
- 5) For general inch sizes, use **Chart 50**, or **Chart 17000** on page 23.

Selecting a back-up ring

One or more back-up rings are used to prevent extrusion of an elastomeric 'O' ring under arduous operating conditions.

Our standard back-up rings are machined in PTFE and normally supplied in single turn or spiral form. See page 12 for more details on back-up rings.

Back-up rings for use with James Walker 'O' ring number

Refer to *How to order* section on page 7 for precise specification details relating to back-up rings for **Chart 50**, **Chart 72** and **Chart 17000** applications.

Back-up ring for use with existing 'O' ring

- 1) Identify appropriate Chart and part number for existing 'O' ring. (*Note: If a standard 'O' ring has been used on a non-standard shaft or cylinder — ie, compressed or stretched into place — the equivalent standard back-up ring must not be used as it cannot be stretched or squeezed in the same way.*)

- 2) Refer to *How to order* section on page 7 for precise specification details.

Back-up ring for use with non-standard size 'O' ring

Please contact our Technical Support Team for recommendations on the correct back-up ring.

Back-up ring for a new application

- 1) Select the 'O' ring you require from our Charts, using the method outlined earlier on this page.
- 2) Refer to *How to order* section on page 7 for precise specification details.

How to use this guide

Selecting a material

Stocked material grades

Standard compound reference	Rubber type	Specifications	Stocked	Colour	ASTM D2000 reference
PB80	'Medium' nitrile (NBR)	BS6996 Grade BO80	✓	Black	ASTM D2000 M2BG 810, B14, EF11, EF21, EO14, EO34. BS5176 2MBG 810, B14, E14, E34, E51, E61
EP18/H/75	Ethylene-propylene (EPM)		✓	Black	ASTM D2000 M3BA 810, A14, B13, Z1. Z1: Hardness 75±5 IRHD
FR10/80	Fluorocarbon (FKM)	DTD 5612A Grade 80**	✓	Black	ASTM D2000 M6HK 810, A1-10, B36
FR25/90*	Fluorocarbon (FKM)		✓	Black	ASTM D2000 M7HK 914, B38, Z1
FR58/90*	Fluorocarbon (FKM)		✓	Black	ASTM D2000 M3HK 910, A1-10, B38, Z1
Elast-O-Lion® 101*	Hydrogenated nitrile (HNBR)		✓	Black	
Elast-O-Lion® 180	Hydrogenated nitrile (HNBR)		✓	Black	
Elast-O-Lion® 985*	Hydrogenated nitrile (HNBR)		✓	Black	
SIL 80/2	Silicone (VMQ)	BS F153 Grade 80	✓	White	ASTM D2000 7GE 805, A19, B37, EO36, Z1 Z1: colour white BS5176 2MGE 805 A19, B17, Z1 Z1: colour white

*These grades are compounded for Rapid Gas Decompression (RGD) resistance: please consult our Technical Support Team for specific details.

** All DTD specifications have been declared obsolescent.

Red: Please specify on your enquiry or order if you want 'O' rings to meet these specifications.

The *Stocked material grades* table, above, gives details of our nine most widely demanded stocked materials. We recommend that you use one of these, wherever possible, for your 'O' rings. Full details of all readily available materials and their chemical compatibility are given on pages 8-12.

'O' ring sizes shown on Chart 50, Aerospace sizes to BS ISO 3601-1, Chart 72, and Chart 17000 are supplied without mould charges.

If you have any doubts about materials selection, please contact our Technical Support Team for recommendations.

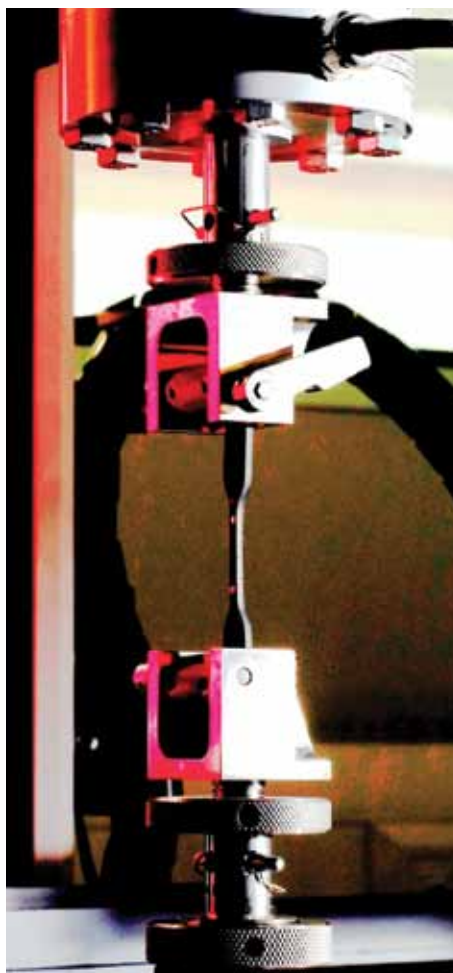

How to use this guide

How to order

The following information and examples will help you to order the correct 'O' ring and back-up ring for specific applications. For critical applications, including those requiring FEP encapsulated 'O' rings, we recommend that you state the following details to enable us to ensure suitability:

- Pressures and pressure media.
- Operating temperatures.
- Static, or dynamic operation with speed.
- Housing type.
- Tolerances.
- Any other important factors.

'O' rings

Standard sizes Charts 50, 72 & 17000:

please state the JW number followed by material reference. *If no material or application conditions are specified, we will supply our PB80 nitrile grade.*

EXAMPLE: JW 50-001 PB80.

Aerospace sizes to BS ISO 3601-1:

please use the following example, where XXXX denotes Size Code, YYY denotes ID, and ZZZ denotes cross-section diameter.

EXAMPLE: 'O' ring – BS ISO 3601-1A-XXXX – YYY x ZZZ – S, in FR10/80 to DTD 5612A Grade 80.

Other sizes: please state ID, cross-section diameter and material.

EXAMPLE: ID 49.4mm, DS 4.1mm, PB80

Back-up rings

Back-up rings are supplied in spiral form unless single turn is stated. Also, they are supplied in PTFE unless otherwise stated.

Back-up ring for Chart 50 inch sizes: for back-up rings to fit inch size shafts and cylinders, state the JW number for the 'O' ring. Also indicate spiral or single turn, and material.

EXAMPLE: For a JW 50-433 (0.275" diameter section) 'O' ring on a 5½" OD shaft or 6" ID cylinder, order JW 50-433 PTFE spiral back-up ring.



Back-up rings for Chart 50 metric sizes:

When ordering back-up rings to match our suggested Chart 50 metric shaft and cylinder sizes, please use:

- Prefix **150** for shaft applications.
- Prefix **250** for cylinder applications.
- Also indicate spiral or single turn and material.

(The reason is that 'O' rings can be stretched or squeezed slightly — see *General design notes* on pages 27-28 — but the back-up ring must be manufactured exactly to suit the shaft or cylinder.)

EXAMPLE 1: For 140mm OD shaft, order JW 150-433 PTFE spiral back-up ring.

EXAMPLE: For 155mm ID cylinder, order JW 250-433 PTFE spiral back-up ring.

Back-up rings for Aerospace Sizes to BS ISO 3601-1: Please contact our Technical Support Team for back-up rings to BS ISO 3601-4.

Back-up rings for Chart 72: When ordering back-up rings (which cover those to BS 5106) please state the same JW 72 number as the 'O' ring. Also indicate spiral or single turn, and material.

EXAMPLE: JW 72-1393-57 PTFE spiral back-up ring.

Back-up rings for other sizes: When ordering back-up rings to match 'O' rings that are not listed in our charts, please state the following:

- 1) Spiral or single turn, and material.
- 2) Back-up ring dimensions, if known, or
- 3) 'O' ring inside diameter B; 'O' ring section diameter A; shaft or cylinder diameter (C or D); housing width and depth (E and F) — see page 29.

EXAMPLE: PTFE spiral back-up ring to use with a 49.4mm ID x 4.1mm DS 'O' ring on a 50mm diameter shaft. Housing width 7.1mm, depth 3.5mm.

Note: Back-up rings are manufactured to suit housing sizes, rather than 'O' ring sizes. Therefore back-up rings cannot be supplied based on 'O' ring dimensions alone.

Subsequent orders

When re-ordering from James Walker, please state the Re-Order Part Number (eg, OB03400X) shown on our documentation that acknowledges your previous order. This will ensure the swiftest service.

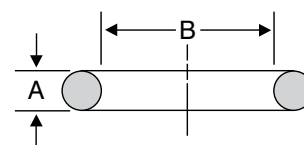

'O' ring diameter section A and inside diameter B.

Materials & properties

General materials

Note: Materials for stocked 'O' rings are **printed in red**. For specific details please see *Selecting a material* on page 6.

Nitrile — acrylonitrile-butadiene (NBR) **Stocked grade: PB80**

We have a very wide range of compounds based on various acrylonitrile/butadiene ratios. Higher nitrile content generally gives better hydrocarbon resistance, whereas lower acrylonitrile content gives better low temperature flexibility. Our PB range is suitable for use with mineral oils — particularly hydraulic types — as well as water and some solvents. Our Proteus range is generally suitable for aqueous food applications, but please consult our Technical Support Team on specific applications before ordering.

Chloroprene (CR) — eg, neoprene

These general purpose elastomers are largely unaffected by sunlight and atmospheric ageing. They give satisfactory service in many media, such as mineral lubricating oils and greases, dilute acids and alkalis, and some solvents.

Natural rubber (NR)

Materials based on natural rubber have high strength and high resilience with good abrasion resistance. They are suitable for use with hot and cold water, ammonia, ethylene glycol, and dilute acids and alkalis. Limited resistance to heat, weathering, and oils has reduced the use of natural rubbers in favour of synthetic elastomers.

Ethylene-propylene (EPM, EPDM)

Stocked grade: EP18/H/75

These compounds have excellent resistance to weathering, ozone, hot and cold water and steam. EPM grades are available for use with water up to 180°C, making them ideal for steam-raising plant. These materials also display resistance to aliphatic phosphate-ester hydraulic fluids, acids, alkalis, salt solutions, alcohols, glycols and silicone oils.

'O' rings in our EP62 range of materials have been WRAS approved for potable water applications, with cold and hot water up to 85°C.

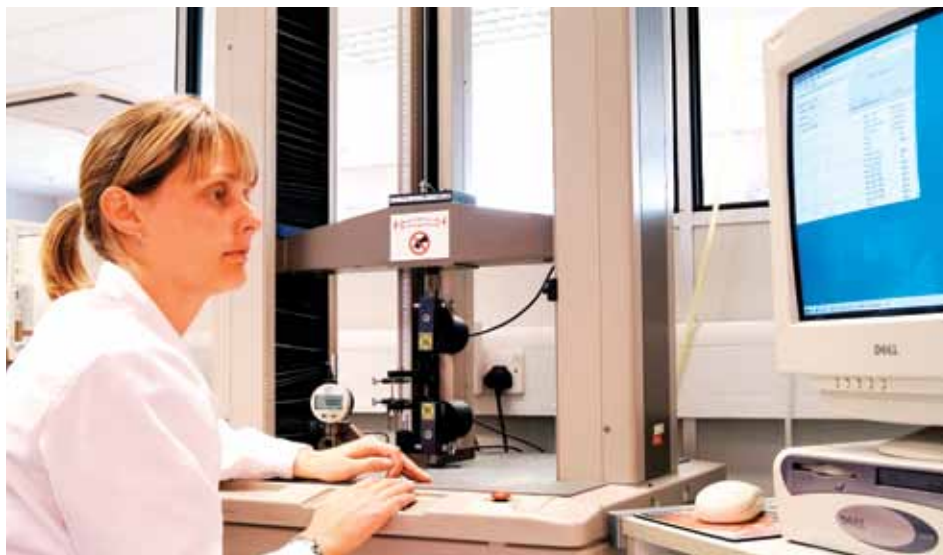

Butyl — isobutene-isoprene (IIR)

Butyl elastomer has similar chemical resistance to ethylene-propylene. Very low gas permeability makes butyl popular for vacuum and high-pressure gas applications. It must **not** be used with mineral oils.

Epichlorhydrin (ECO)

Compounds based on this elastomer have good resistance to mineral oils, fuels and ozone. Corrosive properties and poor compression set resistance limit the use of these materials for sealing applications.

Chlorosulphonyl polyethylene (CSM)

These elastomers show excellent resistance to weathering and give good service in many media. They are **not** recommended for dynamic seals as compression set resistance is limited.

Polyurethane (AU, EU)

Stress relaxation at above 50°C often precludes these elastomers from 'O' ring *sealing* applications. However many polyurethane 'O' rings are used in drive transmissions where their tensile strength, elongation characteristics and wear resistance prove invaluable.

These materials also have excellent resistance to weathering and oxygen, and good resistance to hydrocarbon fuels and mineral oils. Resistance to acids is low, and some grades are affected by water and humidity.

Fluorosilicone (FVMQ, FMQ)

Fluorosilicone grades are available for applications involving hydrocarbon oils, petroleum fuels, and mineral-based hydraulic fluids. This material is primarily used for static seals in aerospace fuel systems. It has similar mechanical limitations to silicone.

Silicone (VMQ)

Stocked grade: SIL 80/2

Many grades of silicone elastomer are available. They offer good resistance to weathering, and compression set at high temperatures, plus excellent electrical resistance. Their use is limited by high gas permeability, low tensile strength and poor resistance to tear and abrasion. Some grade are suitable for food applications.

Materials & properties

High performance materials

Fluoroelastomers (FKM) — eg, Viton®, Tecnoflon®, Dyneon® base polymers
Stocked grades: FR10/80, FR25/90, FR58/90

Fluoroelastomers operate efficiently under severe chemical conditions and at higher temperatures where many other seal materials cannot survive. According to grade, they are well suited to arduous applications involving:

- Temperatures from -41°C to +250°C.
- Petroleum fuels and mineral-based hydraulic fluids.
- Many solvents.

We have developed numerous grades of fluoroelastomers, including the following:

General purpose fluoroelastomers

FR10: Dipolymer-based range with hardnesses of 50 to 90 IRHD. These grades are ideal for general applications and meet UK Ministry of Defence (DTD) low compression set specifications.

FR17: Terpolymer-based range with hardnesses of 65 to 95 IRHD. It has enhanced chemical resistance and better high temperature flexibility characteristics than FR10, although these properties are — to some extent — at the expense of compression set resistance.

FR44: Dipolymer-based range with hardnesses of 50 to 90 IRHD. It comes in a distinctive shade of green for easy identification. These low compression set grades meet many regularly used specifications.

Special fluoroelastomer grades

Many grades are available for specific duties, including the following:

FR68/90: First of our new generation of oil and gas materials. This low compression set elastomer offers excellent resistance to rapid gas decompression (RGD), plus enhanced resistance to sour gas, amines and steam/hot water. We are market leader in the design and manufacture of seals for RGD environments (see page 11).

FR58/90 & 98: These terpolymer-based grades resist rapid gas decompression (RGD) as described on page 11, and have good all round elastomeric properties.

FR25: Tetrapolymer-based range with hardnesses of 70 to 90 IRHD. It offers fluid resistance approaching that of our FR10 range, together with improved low temperature characteristics. FR25/90 is compounded for RGD resistant duties down to -41°C.

FR64/70 & 80: Dipolymer-based grades that offer enhanced performance in steam, hot water and mineral acids.

LR5853: Tetrapolymer-based range with hardnesses of 80, 90 and 98 IRHD. It has enhanced fluid resistance, especially with methanol and gasoline-alcohol blends that affect other fluoroelastomers. These grades stiffen below -5°C, thus LR6316 and FR25 are recommended for low temperature applications.

LR6316: Available in hardnesses of 75 and 90 IRHD, this compound is based on a special tetrapolymer with a similar fluid resistance to LR5853, plus improved low temperature characteristics for service down to -29°C.

Aflas® (FEPM)

These compounds have resistance to lubricants and some fuels approaching that of fluorocarbon dipolymers but, in addition, are suitable for sour gas duties or where amines and high temperature water or steam are used.

AF85: Available in hardnesses of 70, 80 and 90 IRHD. Typical maximum service temperature is 200°C although higher temperatures can be sustained in some media: eg, 260°C in steam. Other special grades are available, such as AF69/90 that is compounded for rapid gas decompression (RGD) resistance.

Kalrez® — perfluoroelastomer (FFKM)

These materials offer almost universal chemical resistance, with grades available for continuous duties up to 325°C. James Walker is Authorised Distributor in the UK, Ireland and France for the design, supply and technical support of sealing and fluid handling parts made from DuPont Performance Elastomer's Kalrez®.

Fluolion® (PTFE)

Fluolion® is James Walker's registered trade name for products manufactured in PTFE. The chemical resistance of virgin PTFE is almost universal — with the exception of molten alkali metals, fluorine gas and elemental fluorine. These chemical properties make PTFE the ideal material for 'O' ring back-up rings.

The flow characteristics of PTFE under stress are a disadvantage in 'O' rings.

Elast-O-Lion® — hydrogenated nitrile (HNBR)

Stocked grades: Elast-O-Lion® 101, 180, 985

Elast-O-Lion® is James Walker's registered trade name for its range of high-performance hydrogenated nitrile compounds.

These materials have the excellent oil/fuel resistance of traditional nitrile (NBR) elastomers with a similar ACN content. They also have superior mechanical properties and can sustain higher service temperatures: eg, 180°C in oil. In addition, they display superior resistance to aggressive fluids such as sour (H₂S) crude oil, lubricating oil additives and amine corrosion inhibitors. Fully saturated grades of HNBR have excellent resistance to ozone.

Four ranges are suitable for 'O' ring manufacture, with various acrylonitrile contents from low to ultra high, and hardnesses from 60 to 90 IRHD. Two grades — Elast-O-Lion 101 and 985 — are extremely well proven in oilfield applications, where mechanical strength, plus resistance to rapid gas decompression (RGD) and chemical attack, is required.

Temperature capability is between -55°C and +180°C, depending on material grade and application.

Materials & properties

Rapid gas decompression

Although rapid gas decompression (RGD) — previously known as explosive decompression (ED) — is a phenomenon generally found in the oil and gas industry, it can occur in any application where there is a rapid drop in gas pressure. Such damage is found in sealing applications ranging from paint guns and fire extinguishers to marine stern glands and systems containing refrigerants.

How damage occurs

RGD damage is structural failure in the forms of blistering, internal cracking and splits, caused when the gas pressure, to which a seal is exposed, rapidly reduces from high to low. Although no strict rules apply, damage should be considered in a gas or dissolved gas system when pressure is greater than 5MPa (725psi), and decompression exceeds 1MPa (145psi) per hour.

The elastomeric parts in a system are, to a greater or lesser degree, susceptible to the permeation and diffusion of gases dissolving in their surface. In time, the elastomer becomes saturated with gases.

Under these conditions — as long as the gas pressure in the elastomer remains at equilibrium with the ambient pressure — there is minimal, if any, damage. Thus, no deterioration in performance of the elastomeric part occurs (unless caused by other factors, eg chemical or thermal degradation or extrusion damage).

When external gas pressure is removed or pressure fluctuations occur, large pressure gradients are created between the interior and surface of the component. This pressure differential may be balanced by the gas diffusing/permeating out of the elastomer, especially if any external constraints are not removed.

But, if the elastomer cannot resist crack or blister growth during the permeation process, then structural failure will result.

Rapid gas decompression damage can manifest itself in various ways — anything from internal splits that are not visible on the surface of the seal, to surface blisters, fractures and complete fragmentation.



James Walker's RGD materials test laboratory

Leader in RGD-resistant elastomers

We have conducted intensive materials development programmes over the past 30 years to help industry overcome RGD problems. Much of this work is carried out in collaboration with plant manufacturers, oil/gas operators and research bodies.

We offer RGD resistant elastomers, which are validated by James Walker Technology Centre. Specific grades are tested and approved by oilfield operators and equipment manufacturers, with several qualified to Norsok M-710 Annex B.

The formulation, mixing, quality control and processing of these compounds is rigorously controlled. Today they are rated as benchmarks by which others are judged. Albeit each compound has a broad range of applications capability, their particular features are as follows:

- **FR68/90** — this fluorocarbon-based material is the first in our new generation of oil and gas elastomers. With new polymer architecture, it offers low compression set, excellent RGD resistance, plus enhanced resistance to sour gas, amines and steam. It is Norsok rated up to at least 8.4mm cross section 'O' rings.
- **FR58/90** — fluorocarbon terpolymer (FKM) material with excellent chemical and thermal properties, plus good RGD resistance. It is widely approved and

specified for oilfield duties, and has also achieved the highest Norsok rating of 0000 with 5.33mm section 'O' rings.

- **FR25/90** — a fluorocarbon tetrapolymer (FKM) that combines improved low temperature capability with excellent chemical properties. It offers excellent RGD resistance, and has achieved the highest Norsok rating of 0000 with 6.99mm and 5.33mm section 'O' rings.
- **Elast-O-Lion® 101** — an hydrogenated nitrile (HNBR) grade with high mechanical strength and wear resistance. It has good resistance to many oilfield chemicals, including H₂S and amine corrosion inhibitors. It is resistant to RGD and approved to many oilfield specifications. It achieved the highest Norsok rating of 0000 with 6.99mm section 'O' rings.
- **Elast-O-Lion® 985** — our hydrogenated nitrile (HNBR) grade with a temperature capability down to -55°C, but offering reduced mechanical properties and RGD resistance when compared to Elast-O-Lion 101.
- **AF69/90** — An Aflas® (FEPM) based RGD-resistant grade with excellent resistance to oilfield media and steam.

For detailed information on RGD-resistant grades see: *Elastomeric seals & components for the Oil & Gas Industry*.

Materials & properties

FEP encapsulated 'O' rings

These have a core of elastomer that is completely covered with a seamless sheath of fluorinated ethylene propylene (FEP). The core is normally fluorocarbon (FKM) or silicone (VMQ).

Encapsulated 'O' rings are generally used when:

- A standard elastomeric 'O' ring has inadequate chemical resistance for a specific application, and
- A solid PTFE 'O' ring does not offer sufficient elasticity for reliable, long-term fluid sealing.

They are used where high levels of chemical resistance or hygiene are needed — typically in petrochemical, chemical, food or pharmaceutical plant.

Although FEP encapsulated 'O' rings are most suited to static duties, they may be used with slow short movements on rotary applications such as valve stem sealing.



Their advantages are manifold, including:

- Excellent chemical resistance to a wide range of media. *Please contact our Technical Support Team for details.*
- Operational temperature ranges of:
-60°C to +200°C with silicone core.
-20°C to +200°C with fluorocarbon core.
- Low friction and low 'stick-slip' effect.
- Far greater elasticity than solid PTFE.

Our FEP encapsulated 'O' rings are fully interchangeable with standard 'O' rings.

However, due to the FEP sheath, they are less flexible than elastomeric rings and have limited stretch with higher permanent deformation. Auxiliary tools may be needed to facilitate efficient fitting.

Back-up rings

Back-up rings are installed to prevent the extrusion of the 'O' ring. They are manufactured from Fluolion[®] PTFE (virgin or filled), and PEEK[™].

They are recommended for applications where:

- System pressure exceeds 10MPa (1450psi), or 'O' rings of low strength elastomer are used, or
- Adverse mechanical conditions exist.

Please consult our Technical Support Team if system pressure exceeds 42MPa (6092psi).

Two back-up rings — one either side of the 'O' ring in its housing — are needed when the application is double-acting.

Our back-up rings are usually supplied as a spiral of two turns. This enables the back-up ring to be opened with ease for fitting over a shaft and ensures the 'O' ring is supported around its entire diameter.

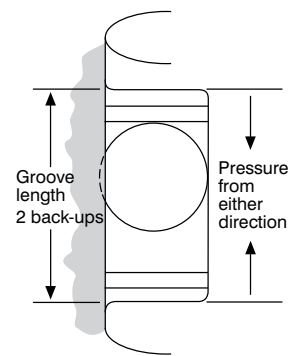
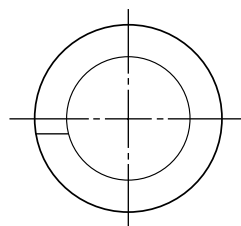
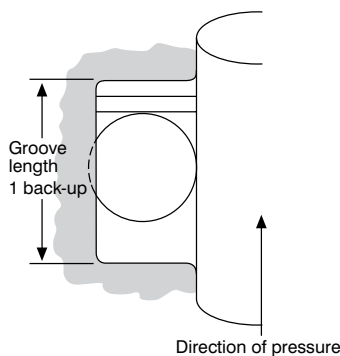

Single-turn back-up rings can also be supplied, and these are usually endless to ensure good support. However, they can be scarf split if required, although we do not recommend this because extrusion can occur at the split.

Back-up rings less than 3mm ID are available only as a single turn — 3mm ID is the smallest size suitable for machining as a two-turn spiral.

Chart 50: inch & metric sizes

James Walker Chart 50 reflects the standards in many countries, particularly those of the UK and USA. For ordering details, please see page 7.

Reference numbers printed in **red** indicate sizes covered by:

- **BS 1806:** Dimensions of toroidal sealing rings ('O' rings) and their housings (inch sizes),
- **BS ISO 3601-1:** Fluid power systems — 'O' rings Part 1: Inside diameters, cross-sections, tolerances and designation codes, and
- **SAE AS 568:** American National Standard Aerospace size standard for 'O' rings.

Although the basic range is in inches, the 'O' rings can of course be used for sealing metric dimensioned components. Chart 50 included suggested metric shaft and cylinder sizes for which each individual 'O' ring is suitable. (Note: these figures are NOT merely direct metric conversions of inch sizes. Also, separate ranges of back-up rings are available for metric shafts and cylinders — see page 7 for ordering references.)

BS ISO 3601 sizes & tolerances

BS 1806 has been superseded by **BS ISO 3601-1** (dimensions) and **BS ISO 3601-2** (housings), but BS 1806 is still widely referenced by industry. The size codes in BS ISO 3601-1 (non-aerospace) are, with a few exceptions, the same as BS 1806. However, there are two tolerance bands, **Class A** and **Class B**, with the tighter tolerances of Class A equating to BS 1806. Our **Chart 50** meets the **Class A** tolerances.

The **A** suffix size codes in BS 1806 (eg, 445A) do not appear as standard sizes in BS ISO 3601-1, but have been retained in Chart 50 as they are still requested.

Using a size code reference such as 445A can result in different size seals being supplied depending on whether BS 1806 or BS ISO 3601-1 is involved. For example, using BS ISO 3601-1, a reference of 445A would indicate a size code of 445 with Class A tolerances.

Thus, when ordering an A suffix size code from BS 1806, it is important to quote BS 1806 and not just the size code.

* Static/dynamic applications

An asterisk symbol (*) denotes that the ring is suitable for both dynamic and static applications. Other sizes are not recommended for dynamic duties.

Housing details can be referred to on pages 29-31.

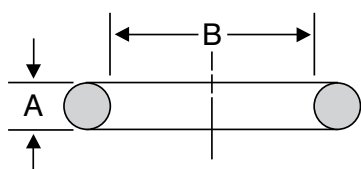

'O' ring diameter section A and inside diameter B.

Refer to page 29 for List of Symbols

James Walker Number	INCH DIAMETERS			METRIC DIAMETERS (mm)		
	Inside Dia. B	C, P, T	D, Q	Inside Dia. B	Shaft C	Cyl. D
0.040 ±0.003" (1.02 ±0.08mm) Diameter Section A						
50-001	0.029 ±0.004	1/32	3/32	0.74 ±0.10	0.8	2.5
" 606	0.070 ±0.005	5/64	9/64	1.78 ±0.13	2	3.6
" 607	0.100 "	7/64	11/64	2.54 "	2.8	4.5
0.050 ±0.003" (1.27 ±0.08mm) Diameter Section A						
50-002	0.042 ±0.004	3/64	0.130	1.07 ±0.10	1.2	3.3
0.060 ±0.003" (1.52 ±0.08mm) Diameter Section A						
50-003	0.056 ±0.004	1/16	11/64	1.42 ±0.10	1.5	4.1
0.070 ±0.003" (1.78 ±0.08mm) Diameter Section A						
50-004*	0.070 ±0.005	5/64	13/64	1.78 ±0.13	2	5
" 005*	0.101 "	7/64	15/64	2.57 "	2.8	6
" 006*	0.114 "	1/8	1/4	2.90 "	3	6.2
" 801*	0.125 "	9/64	17/64	3.18 "	3.5	6.5
" 007*	0.145 "	5/32	9/32	3.68 "	4	7
" 008*	0.176 "	3/16	5/16	4.47 "	4.5	8
" 802*	0.188 "	13/64	21/64	4.76 "	5	8.5
" 009*	0.208 "	7/32	11/32	5.28 "	5.5	9
" 010*	0.239 "	1/4	3/8	6.07 "	6	9.5
" 803*	0.250 "	17/64	29/64	6.35 "	6.5	9.8
" 610*	0.266 "	9/32	13/32	6.75 "	7	10
" 011*	0.301 "	5/16	7/16	7.65 "	7.5	11
" 804*	0.313 "	21/64	29/64	7.94 "	8	11.5
" 611*	0.344 "	11/32	15/32	8.73 "	9	12
" 012*	0.364 "	3/8	1/2	9.25 "	9.5	12.5
" 013	0.426 "	7/16	9/16	10.82 "	11	14.2
" 806	0.438 "	29/64	37/64	11.11 "	11.5	14.5
" 014	0.489 "	1/2	5/8	12.42 "	12.5	16
" 015	0.551 ±0.007	9/16	11/16	14.00 ±0.18	14	17.5
" 016	0.614 ±0.009	5/8	3/4	15.60 ±0.23	15.5	19
" 017	0.676 "	11/16	13/16	17.17 "	17	20.5
" 018	0.739 "	3/4	7/8	18.77 "	19	22.5
" 019	0.801 "	13/16	15/16	20.35 "	20	24
" 020	0.864 "	7/8	1	21.95 "	22	25.5
" 021	0.926 "	15/16	11/8	23.52 "	23	27
" 022	0.989 ±0.010	1	11/8	25.12 ±0.25	25	29
" 023	1.051 "	11/16	13/16	26.70 "	27	30
" 024	1.114 "	11/8	11/4	28.30 "	28	32
" 025	1.176 ±0.011	13/16	15/16	29.87 ±0.28	30	34
" 026	1.239 "	11/4	13/8	31.47 "	31	35
" 027	1.301 "	15/16	17/16	33.05 "	32	37
" 028	1.364 ±0.013	13/8	11/2	34.65 ±0.33	35	38
517	1.428 "	17/16	19/16	36.27 "	36	40
" 029	1.489 "	11/2	15/8	37.82 "	38	42
519	1.553 "	19/16	111/16	39.45 "	39	43
" 030	1.614 "	15/8	13/4	41.00 "	40	45
" 031	1.739 ±0.015	13/4	11/2	44.17 ±0.38	44	48
" 032	1.864 "	17/8	2	47.35 "	47	51
" 033	1.989 ±0.018	2	21/8	50.52 ±0.46	50	55
" 034	2.114 "	21/4	21/4	53.70 "	53	58
" 035	2.239 "	21/4	23/8	56.87 "	56	61
" 036	2.364 "	23/8	21/2	60.05 "	60	65
" 037	2.489 "	21/2	23/4	63.22 "	63	67
" 038	2.614 ±0.020	25/8	23/4	66.40 ±0.51	65	70
" 039	2.739 "	23/4	23/8	69.57 "	69	75
" 040	2.864 "	27/8	3	72.75 "	70	77
" 041	2.989 ±0.024	3	31/8	75.92 ±0.61	75	80
532	3.110 "	31/8	31/4	78.99 "	78	85
" 042	3.239 "	31/4	33/8	82.27 "	80	88
534	3.360 "	33/8	31/2	85.34 "	85	90
" 043	3.489 "	31/2	33/8	88.62 "	88	95
536	3.610 ±0.027	33/8	33/4	91.69 ±0.69	90	98
" 044	3.739 "	33/4	37/8	94.97 "	95	100
538	3.860 "	37/8	4	98.04 "	98	102
" 045	3.989 "	4	41/8	101.32 "	100	105
540	4.110 "	41/8	41/4	104.39 "	104	110
" 046	4.239 ±0.030	41/4	43/8	107.67 ±0.76	107	112
542	4.360 "	43/8	41/2	110.74 "	110	115
" 047	4.489 "	41/2	43/4	114.02 "	114	120
544	4.610 "	43/4	43/4	117.09 "	116	122
" 048	4.739 "	43/4	47/8	120.37 "	120	125
546	4.860 ±0.037	47/8	5	123.44 ±0.94	123	130
" 049	4.989 "	5	51/8	126.72 "	125	132
548	5.095 "	51/8	51/4	129.41 "	130	135
" 050	5.239 "	51/4	53/8	133.07 "	132	138

Chart 50: inch & metric sizes

Refer to page 29 for List of Symbols

James Walker Number	INCH DIAMETERS			METRIC DIAMETERS (mm)		
	Inside Dia. B	C, P, T	D, Q	Inside Dia. B	Shaft C	Cyl. D
0.070 ±0.003" (1.78 ±0.08mm) Diameter Section A						
50-550	5.345 ±0.037	5 ³ / ₈	5 ¹ / ₂	135.76 ±0.94	135	140
" 551	5.470 "	5 ¹ / ₂	5 ⁵ / ₈	138.94 "	138	145
" 552	5.595 "	5 ⁵ / ₈	5 ³ / ₄	142.11 "	140	148
" 553	5.720 "	5 ³ / ₄	5 ⁷ / ₈	145.29 "	145	150
" 554	5.845 "	5 ⁷ / ₈	6	148.46 "	148	155
" 555	5.970 "	6	6 ¹ / ₈	151.64 "	150	158
" 556	6.095 ±0.040	6 ¹ / ₈	6 ¹ / ₄	154.81 ±1.02	155	160
" 557	6.220 "	6 ¹ / ₄	6 ³ / ₈	157.99 "	158	162
" 558	6.345 "	6 ³ / ₈	6 ¹ / ₂	161.16 "	160	165
" 559	6.470 "	6 ¹ / ₂	6 ⁵ / ₈	164.34 "	165	170
" 560	6.595 "	6 ⁵ / ₈	6 ³ / ₄	167.51 "	167	172
" 561	6.720 "	6 ³ / ₄	6 ⁷ / ₈	170.69 "	170	175
" 562	6.845 "	6 ⁷ / ₈	7	173.86 "	174	180
0.103 ±0.003" (2.62 ±0.08mm) Diameter Section A						
50-102*	0.049 ±0.005	1 ¹ / ₁₆	1 ¹ / ₄	1.24 ±0.13	1.5	6
" 103*	0.081 "	3 ¹ / ₃₂	9 ¹ / ₃₂	2.06 "	2.3	7
" 104*	0.112 "	1 ¹ / ₈	5 ¹ / ₁₆	2.84 "	3	7.5
" 105*	0.143 "	5 ¹ / ₃₂	1 ¹ / ₈	3.63 "	4	8.5
" 106*	0.174 "	3 ¹ / ₁₆	3 ¹ / ₈	4.42 "	4.5	9.5
" 107*	0.206 "	7 ¹ / ₃₂	1 ³ / ₃₂	5.23 "	5.5	10
" 108*	0.237 "	1 ¹ / ₄	7 ¹ / ₁₆	6.02 "	6	11
" 109*	0.299 "	5 ¹ / ₁₆	1 ¹ / ₂	7.59 "	7.5	12.5
" 110*	0.362 "	3 ¹ / ₈	9 ¹ / ₁₆	9.19 "	9.5	14
" 613*	0.391 "	1 ¹ / ₃₂	1 ¹ / ₃₂	9.92 "	10	15
" 111*	0.424 "	7 ¹ / ₁₆	5 ¹ / ₈	10.77 "	11	16
" 614*	0.469 "	1 ¹ / ₃₂	2 ¹ / ₃₂	11.91 "	11.5	17
" 112*	0.487 "	1 ¹ / ₂	1 ¹ / ₁₆	12.37 "	12	17.5
" 807*	0.500 ±0.007	—	—	12.70 ±0.18	12.5	17.8
" 615*	0.516 "	3 ¹ / ₆₄	4 ¹ / ₆₄	13.10 "	13	18
" 113*	0.549 "	9 ¹ / ₁₆	3 ¹ / ₄	13.94 "	14	19
" 616*	0.594 "	1 ¹ / ₃₂	2 ¹ / ₃₂	15.08 "	15	20
" 114*	0.612 ±0.009	5 ¹ / ₈	1 ¹ / ₈	15.54 ±0.23	15.5	20.5
" 809*	0.625 "	4 ¹ / ₆₄	5 ¹ / ₆₄	15.88 "	16	21
" 115*	0.674 "	1 ¹ / ₁₆	7 ¹ / ₈	17.12 "	17	22
" 810*	0.688 "	4 ¹ / ₆₄	5 ¹ / ₆₄	17.46 "	17.5	22.5
" 617*	0.703 "	2 ¹ / ₃₂	2 ¹ / ₃₂	17.86 "	18	23
" 116*	0.737 "	3 ¹ / ₄	1 ¹ / ₁₆	18.72 "	19	24
" 117	0.799 ±0.010	1 ¹ / ₁₆	1	20.29 ±0.25	20	25.5
" 812	0.813 "	5 ¹ / ₆₄	1 ¹ / ₆₄	20.64 "	20.5	26
" 118	0.862 "	7 ¹ / ₈	1 ¹ / ₁₆	21.89 "	21	27
" 813	0.875 "	5 ¹ / ₆₄	1 ¹ / ₆₄	22.23 "	22	27.5
" 119	0.924 "	1 ¹ / ₁₆	1 ¹ / ₁₆	23.47 "	23	28.5
" 814	0.938 "	6 ¹ / ₆₄	1 ¹ / ₆₄	23.81 "	23.5	29
" 120	0.987 "	1	1 ¹ / ₁₆	25.07 "	25	30
" 121	1.049 "	1 ¹ / ₁₆	1 ¹ / ₄	26.64 "	27	32
" 122	1.112 "	1 ¹ / ₈	1 ¹ / ₁₆	28.24 "	28	34
" 123	1.174 ±0.012	1 ¹ / ₁₆	1 ¹ / ₈	29.82 ±0.30	30	35
" 124	1.237 "	1 ¹ / ₄	1 ¹ / ₁₆	31.42 "	31	37
" 125	1.299 "	1 ¹ / ₁₆	1 ¹ / ₂	32.99 "	32	38
" 126	1.362 "	1 ¹ / ₈	1 ¹ / ₁₆	34.59 "	35	40
" 127	1.424 "	1 ¹ / ₁₆	1 ¹ / ₈	36.17 "	36	42
" 128	1.487 "	1 ¹ / ₂	1 ¹ / ₁₆	37.77 "	38	43
" 129	1.549 ±0.015	1 ¹ / ₁₆	1 ³ / ₄	39.34 ±0.38	39	45
" 130	1.612 "	1 ¹ / ₈	1 ¹ / ₁₆	40.94 "	40	47
" 131	1.674 "	1 ¹ / ₁₆	1 ¹ / ₈	42.52 "	42	48
" 132	1.737 "	1 ¹ / ₄	1 ¹ / ₁₆	44.12 "	44	50
" 133	1.799 "	1 ¹ / ₁₆	2	45.69 "	45	51
" 134	1.862 "	1 ¹ / ₈	2 ¹ / ₁₆	47.29 "	47	53
" 135	1.925 ±0.017	1 ¹ / ₁₆	2 ¹ / ₈	48.90 ±0.43	48	55
" 136	1.987 "	2	2 ¹ / ₁₆	50.47 "	50	56
" 137	2.050 "	2 ¹ / ₁₆	2 ¹ / ₄	52.07 "	52	58
" 138	2.112 "	2 ¹ / ₈	2 ¹ / ₁₆	53.64 "	53	60
" 139	2.175 "	2 ¹ / ₁₆	2 ¹ / ₈	55.25 "	55	61
" 140	2.237 "	2 ¹ / ₄	2 ¹ / ₁₆	56.82 "	56	62
" 141	2.300 ±0.020	2 ¹ / ₁₆	2 ¹ / ₂	58.42 ±0.51	58	65
" 142	2.362 "	2 ¹ / ₈	2 ¹ / ₁₆	59.99 "	60	66
" 143	2.425 "	2 ¹ / ₁₆	2 ¹ / ₈	61.60 "	61	67
" 144	2.487 "	2 ¹ / ₂	2 ¹ / ₁₆	63.17 "	63	69
" 145	2.550 "	2 ¹ / ₁₆	2 ³ / ₄	64.77 "	65	70

James Walker Number	INCH DIAMETERS			METRIC DIAMETERS (mm)		
	Inside Dia. B	C, P, T	D, Q	Inside Dia. B	Shaft C	Cyl. D
0.103 ±0.003" (2.62 ±0.08mm) Diameter Section A						
" 146	2.612 ±0.020	2 ⁵ / ₁₆	2 ¹ / ₁₆	66.34 ±0.51	66	72
" 147	2.675 ±0.022	2 ¹ / ₁₆	2 ¹ / ₈	67.95 ±0.56	68	74
" 148	2.737 "	2 ³ / ₄	2 ¹ / ₁₆	69.52 "	69	75
" 149	2.800 "	2 ¹ / ₁₆	3	71.12 "	70	77
" 150	2.862 "	2 ⁷ / ₈	3 ¹ / ₁₆	72.69 "	72	78
" 640	2.924 ±0.024	2 ¹ / ₁₆	3 ¹ / ₈	74.27 ±0.61	74	80
" 151	2.987 "	3	3 ¹ / ₁₆	75.87 "	75	82
" 641	3.049 "	3 ¹ / ₁₆	3 ¹ / ₄	77.44 "	77	85
" 642	3.174 "	3 ³ / ₁₆	3 ³ / ₈	80.62 "	80	87
" 152	3.237 "	3 ¹ / ₄	3 ¹ / ₁₆	82.22 "	82	88
" 643	3.299 "	3 ⁵ / ₁₆	3 ¹ / ₂	83.79 "	84	90
" 153	3.487 "	3 ¹ / ₂	3 ¹ / ₁₆	88.57 "	88	95
" 154	3.737 ±0.028	3 ³ / ₄	3 ¹ / ₁₆	94.92 ±0.71	95	100
" 155	3.987 "	4	4 ¹ / ₁₆	101.27 "	100	110
" 156	4.237 ±0.030	4 ¹ / ₄	4 ¹ / ₁₆	107.62 ±0.76	107	115
" 157	4.487 "	4 ¹ / ₂	4 ¹ / ₁₆	113.97 "	114	120
" 158	4.737 "	4 ³ / ₄	4 ¹ / ₁₆	120.32 "	120	130
" 159	4.987 ±0.035	5	5 ¹ / ₁₆	126.67 ±0.89	125	135
" 160	5.237 "	5 ¹ / ₄	5 ¹ / ₁₆	133.02 "	132	140
" 161	5.487 "	5 ¹ / ₂	5 ¹ / ₁₆	139.37 "	138	145
" 162	5.737 "	5 ³ / ₄	5 ¹ / ₁₆	145.72 "	145	155
" 163	5.987 "	6	6 ¹ / ₁₆	152.07 "	150	160
" 164	6.237 ±0.040	6 ¹ / ₄	6 ¹ / ₁₆	158.42 ±1.02	158	165
" 165	6.487 "	6 ¹ / ₂	6 ¹ / ₁₆	164.77 "	165	170
" 166	6.737 "	6 ³ / ₄	6 ¹ / ₁₆	171.12 "	170	180
" 167	6.987 "	7	7 ¹ / ₁₆	177.47 "	177	185
" 168	7.237 ±0.045	7 ¹ / ₄	7 ¹ / ₁₆	183.82 ±1.14	183	190
" 169	7.487 "	7 ¹ / ₂	7 ¹ / ₁₆	190.17 "	190	200
" 170	7.737 "	7 ³ / ₄	7 ¹ / ₁₆	196.52 "	195	205
" 171	7.987 "	8	8 ¹ / ₁₆	202.87 "	200	210
" 172	8.237 ±0.050	8 ¹ / ₄	8 ¹ / ₁₆	209.22 ±1.27	208	215
" 173	8.487 "	8 ¹ / ₂	8 ¹ / ₁₆	215.57 "	215	225
" 174	8.737 "	8 ³ / ₄	8 ¹ / ₁₆	221.92 "	220	230
" 175	8.987 "	9	9 ¹ / ₁₆	228.27 "	225	235
" 176	9.237 ±0.055	9 ¹ / ₄	9 ¹ / ₁₆	234.62 ±1.40	235	240
" 177	9.487 "	9 ¹ / ₂	9 ¹ / ₁₆	240.97 "	240	250
" 178	9.737 "	9 ³ / ₄	9 ¹ / ₁₆	247.32 "	245	255
0.139 ±0.004" (3.53 ±0.10mm) Diameter Section A						
50-201*	0.171 ±0.005	3 ¹ / ₁₆	7 ¹ / ₁₆	4.34 ±0.13	4.5	11
" 202*	0.234 "	1 ¹ / ₄	1 ¹ / ₂	5.94 "	6	12.5
" 203*	0.296 "	5 ¹ / ₁₆	9 ¹ / ₁₆	7.52 "	7.5	14
" 204*	0.359 "	3 ¹ / ₈	5 ¹ / ₈	9.12 "	9.5	16
" 205*	0.421 "	7 ¹ / ₁₆	1 ¹ / ₁₆	10.69 "	11	17.5
" 206*	0.484 "	1 ¹ / ₂	3 ¹ / ₄	12.29 "	12.5	19
" 207*	0.546 ±0.007	9 ¹ / ₁₆	1 ¹ / ₁₆	13.87 ±0.18	14	20.5
" 208*	0.609 ±0.009	5 ¹ / ₈	7 ¹ / ₈	15.47 ±0.23	15.5	22
" 209*	0.671 "	1 ¹ / ₁₆	1 ¹ / ₁₆	17.04 "	17	24
" 210*	0.734 ±0.010	3 ¹ / ₄	1	18.64 ±0.25	19	25
" 211*	0.796 "	1 ¹ / ₁₆	1 ¹ / ₁₆	20.22 "	20	28
" 212*	0.859 "	7 ¹ / ₈	1 ¹ / ₈	21.82 "	22	29
" 213*	0.921 "	1 ¹ / ₁₆	1 ¹ / ₁₆	23.39 "	23	30
" 214*	0.984 "	1	1 ¹ / ₄	24.99 "	25	32
" 618*	1.016 "	1 ¹ / ₃₂	1 ¹ / ₃₂	25.80 "	26	33
" 215*	1.046 "	1 ¹ / ₁₆	1 ¹ / ₁₆	26.57 "	27	34
" 216*	1.109 ±0.012	1 ¹ / ₈	1 ¹ / ₈	28.17 ±0.30	28	35
" 217*	1.171 "	1 ¹ / ₁₆	1 ¹ / ₁₆	29.7		

Chart 50: inch & metric sizes

Refer to page 29 for List of Symbols

James Walker Number	INCH DIAMETERS			METRIC DIAMETERS (mm)		
	Inside Dia. B	C, P, T	D, Q	Inside Dia. B	Shaft C	Cyl. D
0.139 ±0.004" (3.53 ±0.10mm) Diameter Section A						
" 832	2.063 ±0.018	2 ¹ / ₁₆	2 ⁵ / ₁₆	52.39 ±0.46	52	60
" 227	2.109 "	2 ¹ / ₈	2 ³ / ₈	53.57 "	53	61
" 833	2.125 "	—	—	53.98 "	54	62
" 834	2.188 "	2 ³ / ₁₆	2 ⁷ / ₁₆	55.56 "	55	63
" 228	2.234 ±0.020	2 ¹ / ₄	2 ¹ / ₂	56.74 ±0.51	56	64
" 835	2.250 "	—	—	57.15 "	57	65
" 836	2.313 "	2 ⁵ / ₁₆	2 ⁹ / ₁₆	58.74 "	58	66
" 229	2.359 "	2 ³ / ₈	2 ⁵ / ₈	59.92 "	59	67
" 837	2.375 "	—	—	60.33 "	60	68
" 838	2.438 "	2 ¹ / ₈	2 ¹ / ₁₆	61.91 "	61	69
" 230	2.484 "	2 ¹ / ₂	2 ³ / ₄	63.09 "	62	70
" 839	2.500 "	—	—	63.50 "	63	71
" 840	2.563 "	2 ³ / ₁₆	2 ⁷ / ₁₆	65.09 "	64	72
" 231	2.609 "	2 ⁵ / ₁₆	2 ⁹ / ₁₆	66.27 "	65	73
" 841	2.625 "	—	—	66.68 "	66	74
" 842	2.688 "	2 ¹ / ₁₆	2 ⁵ / ₁₆	68.26 "	67	75
" 232	2.734 ±0.024	2 ³ / ₄	3	69.44 ±0.61	68	76
" 843	2.750 "	—	—	69.85 "	69	77
" 844	2.813 "	2 ³ / ₁₆	3 ¹ / ₁₆	71.44 "	70	79
" 233	2.859 "	2 ⁷ / ₁₆	3 ¹ / ₈	72.62 "	71	80
" 845	2.875 "	—	—	73.04 "	72	81
" 846	2.938 "	2 ¹ / ₁₆	3 ³ / ₁₆	74.61 "	74	82
" 234	2.984 "	3	3 ¹ / ₄	75.79 "	75	85
" 235	3.109 "	3 ³ / ₈	3 ³ / ₈	78.97 "	78	88
" 236	3.234 "	3 ³ / ₄	3 ¹ / ₂	82.14 "	80	90
" 237	3.359 "	3 ³ / ₈	3 ³ / ₈	85.32 "	85	95
" 238	3.484 "	3 ¹ / ₂	3 ³ / ₄	88.49 "	88	98
" 239	3.609 ±0.028	3 ³ / ₈	3 ³ / ₈	91.67 ±0.71	90	100
" 240	3.734 "	3 ³ / ₄	4	94.84 "	95	102
" 241	3.859 "	3 ⁷ / ₈	4 ¹ / ₈	98.02 "	98	105
" 242	3.984 "	4	4 ¹ / ₄	101.19 "	100	110
" 243	4.109 "	4 ¹ / ₈	4 ³ / ₈	104.37 "	104	112
" 244	4.234 ±0.030	4 ¹ / ₄	4 ¹ / ₂	107.54 ±0.76	107	115
" 245	4.359 "	4 ³ / ₈	4 ³ / ₈	110.72 "	110	120
" 246	4.484 "	4 ¹ / ₂	4 ³ / ₄	113.89 "	114	122
" 247	4.609 "	4 ⁵ / ₈	4 ⁷ / ₈	117.07 "	116	125
" 248	4.734 "	4 ³ / ₄	5	120.24 "	120	130
" 249	4.859 ±0.035	4 ⁷ / ₈	5 ¹ / ₈	123.42 ±0.89	123	132
" 250	4.984 "	5	5 ¹ / ₄	126.59 "	125	135
" 251	5.109 "	5 ¹ / ₈	5 ³ / ₈	129.77 "	130	138
" 252	5.234 ±0.035	5 ¹ / ₄	5 ¹ / ₂	132.94 ±0.89	132	140
" 253	5.359 "	5 ³ / ₈	5 ³ / ₈	136.12 "	135	145
" 254	5.484 "	5 ¹ / ₂	5 ³ / ₄	139.29 "	138	148
" 255	5.609 "	5 ³ / ₄	5 ⁷ / ₈	142.47 "	140	150
" 256	5.734 "	5 ³ / ₄	6	145.64 "	145	155
" 257	5.859 "	5 ⁷ / ₈	6 ¹ / ₈	148.82 "	148	158
" 258	5.984 "	6	6 ¹ / ₄	151.99 "	150	160
" 259	6.234 ±0.040	6 ¹ / ₄	6 ¹ / ₂	158.34 ±1.02	158	170
" 260	6.484 "	6 ¹ / ₂	6 ³ / ₄	164.69 "	165	175
" 261	6.734 "	6 ³ / ₄	7	171.04 "	170	180
" 262	6.984 "	7	7 ¹ / ₄	177.39 "	177	185
" 263	7.234 ±0.045	7 ¹ / ₄	7 ¹ / ₂	183.74 ±1.14	183	195
" 264	7.484 "	7 ¹ / ₂	7 ³ / ₄	190.09 "	190	200
" 265	7.734 "	7 ³ / ₄	8	196.44 "	195	205
" 266	7.984 "	8	8 ¹ / ₄	202.79 "	200	210
" 267	8.234 ±0.050	8 ¹ / ₄	8 ¹ / ₂	209.14 ±1.27	208	220
" 268	8.484 "	8 ¹ / ₂	8 ³ / ₄	215.49 "	215	225
" 269	8.734 "	8 ³ / ₄	9	221.84 "	220	230
" 270	8.984 "	9	9 ¹ / ₄	228.19 "	225	235
" 271	9.234 ±0.055	9 ¹ / ₄	9 ¹ / ₂	234.54 ±1.40	235	245
" 272	9.484 "	9 ¹ / ₂	9 ³ / ₄	240.89 "	240	250
" 273	9.734 "	9 ³ / ₄	10	247.24 "	245	255
" 274	9.984 "	10	10 ¹ / ₄	253.59 "	250	265
" 275	10.484 "	10 ¹ / ₂	10 ³ / ₄	266.29 "	265	275
" 276	10.984 ±0.065	11	11 ¹ / ₄	278.99 ±1.65	275	290
" 277	11.484 "	11 ¹ / ₂	11 ³ / ₄	291.69 "	290	300
" 278	11.984 "	12	12 ¹ / ₄	304.39 "	300	315
" 279	12.984 "	13	13 ¹ / ₄	329.79 "	330	340
" 280	13.984 "	14	14 ¹ / ₄	355.19 "	350	365
" 281	14.984 "	15	15 ¹ / ₄	380.59 "	380	390
" 282	15.955 ±0.075	16	16 ¹ / ₄	405.26 ±1.91	400	415
" 283	16.955 ±0.080	17	17 ¹ / ₄	430.66 ±2.03	430	440
" 284	17.955 ±0.085	18	18 ¹ / ₄	456.06 ±2.16	455	465

James Walker Number	INCH DIAMETERS			METRIC DIAMETERS (mm)		
	Inside Dia. B	C, P, T	D, Q	Inside Dia. B	Shaft C	Cyl. D
0.210 ±0.005" (5.33 ±0.13mm) Diameter Section A						
50-309*	0.412 ±0.005	7 ¹ / ₁₆	1 ¹ / ₁₆	10.46 ±0.13	11	20.5
" 310*	0.475 "	1 ¹ / ₂	7 ¹ / ₈	12.07 "	12.5	22
" 311*	0.537 ±0.007	7 ¹ / ₈	1 ¹ / ₄	13.64 ±0.18	14	23.5
" 312*	0.600 ±0.009	1	1	15.24 ±0.23	15.5	25
" 313*	0.662 "	1 ¹ / ₁₆	1 ¹ / ₁₆	16.81 "	17	27
" 314*	0.725 ±0.010	3 ¹ / ₄	1 ¹ / ₈	18.42 ±0.25	19	28.5
" 315*	0.787 "	1 ¹ / ₁₆	1 ¹ / ₁₆	19.99 "	20	30
" 316*	0.850 "	7 ¹ / ₈	1 ¹ / ₄	21.59 "	22	31.5
" 317*	0.912 "	1 ¹ / ₁₆	1 ¹ / ₁₆	23.16 "	23	33
" 318*	0.975 "	1	1 ¹ / ₈	24.77 "	25	35
" 319*	1.037 "	1 ¹ / ₁₆	1 ¹ / ₁₆	26.34 "	27	36.5
" 320*	1.100 ±0.012	1 ¹ / ₈	1 ¹ / ₂	27.94 ±0.30	28	38
" 321*	1.162 "	1 ¹ / ₁₆	1 ¹ / ₁₆	29.51 "	30	40
" 322*	1.225 "	1 ¹ / ₄	1 ¹ / ₈	31.12 "	31	42
" 323*	1.287 "	1 ¹ / ₁₆	1 ¹ / ₁₆	32.69 "	32	43
" 324*	1.350 "	1 ¹ / ₈	1 ¹ / ₄	34.29 "	35	45
" 325*	1.475 ±0.015	1 ¹ / ₂	1 ¹ / ₈	37.47 ±0.38	38	48
" 326*	1.600 "	1 ¹ / ₈	2	40.64 "	40	52
" 327*	1.725 "	1 ³ / ₄	2 ¹ / ₈	43.82 "	42	55
" 328*	1.850 "	1 ¹ / ₈	2 ¹ / ₄	46.99 "	45	58
" 329*	1.975 ±0.018	2	2 ¹ / ₈	50.17 ±0.46	50	62
" 330*	2.100 "	2 ¹ / ₂	2 ¹ / ₂	53.34 "	52	65
" 331*	2.225 "	2 ¹ / ₄	2 ¹ / ₈	56.52 "	56	68
" 332*	2.350 "	2 ³ / ₄	2 ³ / ₄	59.69 "	60	70
" 333*	2.475 ±0.020	2 ¹ / ₂	2 ¹ / ₈	62.87 ±0.51	63	75
" 334*	2.600 "	2 ⁵ / ₈	3	66.04 "	65	78
" 335*	2.725 "	2 ³ / ₄	3 ¹ / ₈	69.22 "	68	80
" 336*	2.850 "	2 ¹ / ₂	3 ¹ / ₄	72.39 "	70	83
" 619*	2.938 ±0.024	2 ⁵ / ₁₆	3 ¹ / ₈	74.61 ±0.61	72	85
" 337*	2.975 "	3	3 ¹ / ₈	75.57 "	75	88
" 338*	3.100 "	3 ¹ / ₈	3 ¹ / ₂	78.74 "	78	90
" 620*	3.141 "	—	—	79.78 "	80	92
" 339*	3.225 "	3 ¹ / ₄	3 ³ / ₈	81.92 "	82	95
" 340*	3.350 "	3 ³ / ₈	3 ³ / ₄	85.09 "	85	98
" 341*	3.475 "	3 ¹ / ₂	3 ³ / ₈	88.27 "	88	100
" 621*	3.531 ±0.028	3 ³ / ₁₆	3 ⁵ / ₁₆	89.69 ±0.71	90	101
" 342*	3.600 "	3 ³ / ₈	4	91.44 "	92	102
" 343*	3.725 "	3 ³ / ₄	4 ¹ / ₈	94.62 "	95	105
" 344*	3.850 "	3 ⁷ / ₈	4 ¹ / ₄	97.79 "	98	108
" 622*	3.938 "	3 ⁵ / ₁₆	4 ¹ / ₁₆	100.01 "	100	110
" 345*	3.975 "	4	4 ³ / ₈	100.97 "	101	112
" 346*	4.100 "	4 ¹ / ₄	4 ¹ / ₂	104.14 "	104	115
" 347*	4.225 ±0.030	4 ¹ / ₄	4 ³ / ₈	107.32 ±0.76	107	118
" 623*	4.313 "	4 ³ / ₁₆	4 ¹ / ₁₆	109.54 "	109	120
" 348*	4.350 "	4 ¹ / ₈	4 ³ / ₄	110.49 "	110	121
" 349*	4.475 "	4 ¹ / ₂	4 ⁷ / ₈	113.67 "	114	125
" 350	4.600 "	4 ³ / ₈	5	116.84 "	116	128
" 860	4.625 "	—	—	117.48 "	117	130
" 351	4.725 "	4 ³ / ₄	5 ¹ / ₈	120.02 "	120	131
" 861	4.750 "	—	—	120.65 "	121	132
" 352	4.850 "	4 ⁷ / ₈	5 ¹ / ₄	123.19 "	123	134
" 862	4.875 ±0.037	—	—	123.83 ±0.94	124	135
" 353	4.975 "	5	5 ³ / ₈	126.37 "	125	137
" 863	5.000 "	—	—	127.00 "	127	138
" 354	5.100 "	5 ¹ / ₈	5 ¹ / ₂	129.54 "	129	140
" 864	5.125 "	—	—	130.18 "	130	1

Chart 50: inch & metric sizes

Refer to page 29 for List of Symbols

James Walker Number	INCH DIAMETERS			METRIC DIAMETERS (mm)		
	Inside Dia. B	C, P, T	D, Q	Inside Dia. B	Shaft C	Cyl. D
0.210 ±0.005" (5.33 ±0.13mm) Diameter Section A						
" 362	6.225 ±0.040	6¼	6¾	158.12 ±1.02	158	170
" 645	6.350 "	6¾	6¾	161.29 "	160	172
" 363	6.475 "	6¾	6¾	164.47 "	165	175
" 646	6.600 "	6¾	7	167.64 "	167	180
" 364	6.725 "	6¾	7½	170.82 "	170	182
" 647	6.850 "	6¾	7¼	173.99 "	174	185
" 365	6.975 "	7	7¾	177.17 "	177	190
" 366	7.225 ±0.045	7¼	7¾	183.52 ±1.14	183	195
" 367	7.475 "	7½	7¾	189.87 "	190	200
" 368	7.725 "	7¾	8¾	196.22 "	195	210
" 369	7.975 "	8	8¾	202.57 "	200	215
" 370	8.225 ±0.050	8¼	8¾	208.92 ±1.27	208	220
" 371	8.475 "	8½	8¾	215.27 "	215	230
" 372	8.725 "	8¾	9¾	221.62 "	220	235
" 373	8.975 "	9	9¾	227.97 "	225	240
" 374	9.225 ±0.055	9¼	9¾	234.32 ±1.40	235	245
" 375	9.475 "	9½	9¾	240.67 "	240	255
" 376	9.725 "	9¾	10¾	247.02 "	245	260
" 377	9.975 "	10	10¾	253.37 "	250	265
" 378	10.475 ±0.060	10½	10¾	266.07 ±1.52	265	280
" 379	10.975 "	11	11¾	278.77 "	275	290
" 380	11.475 ±0.065	11½	11¾	291.47 ±1.65	290	305
" 381	11.975 "	12	12¾	304.17 "	300	315
" 382	12.975 "	13	13¾	329.57 "	330	340
" 383	13.975 ±0.070	14	14¾	354.97 ±1.78	350	370
" 384	14.975 "	15	15¾	380.37 "	380	395
" 385	15.955 ±0.075	16	16¾	405.26 ±1.91	400	420
" 386	16.955 ±0.080	17	17¾	430.66 ±2.03	430	445
" 387	17.955 ±0.085	18	18¾	456.06 ±2.16	455	470
" 388	18.955 ±0.090	19	19¾	481.46 ±2.29	480	500
" 389	19.955 ±0.095	20	20¾	506.86 ±2.41	505	525
" 390	20.955 "	21	21¾	532.26 "	530	550
" 391	21.955 ±0.100	22	22¾	557.66 ±2.54	555	575
" 392	22.940 ±0.105	23	23¾	582.68 ±2.67	580	600
" 393	23.940 ±0.110	24	24¾	608.08 ±2.79	605	625
" 394	24.940 ±0.115	25	25¾	633.48 ±2.92	630	650
" 395	25.940 ±0.120	26	26¾	658.88 ±3.05	655	675

0.275 ±0.006" (6.99 ±0.15mm) Diameter Section A						
50-425*	4.475 ±0.033	4½	5	113.67 ±0.84	114	127
" 624*	4.516 "	4½	5¼	114.70 "	115	128
" 426*	4.600 "	4¾	5¼	116.84 "	116	130
" 427*	4.725 "	4¾	5¼	120.02 "	120	135
" 428*	4.850 "	4¾	5¾	123.19 "	123	137
" 625*	4.906 ±0.037	4¾	5¾	124.62 ±0.94	125	138
" 429*	4.975 "	5	5½	126.37 "	126	140
" 430*	5.100 "	5	5¾	129.54 "	130	145
" 431*	5.225 "	5¼	5¼	132.72 "	132	147
" 626*	5.297 "	5¼	5¾	134.54 "	135	148
" 432*	5.350 "	5¾	5¾	135.89 "	136	150
" 433*	5.475 "	5¾	6	139.07 "	140	155
" 434*	5.600 "	5¾	6¼	142.24 "	142	158
" 435*	5.725 "	5¾	6¼	145.42 "	145	160
" 436*	5.850 "	5¾	6¾	148.59 "	148	162
" 437*	5.975 "	6	6½	151.77 "	150	165
" 872*	6.125 ±0.040	6	6¾	155.58 ±1.02	155	170
" 438*	6.225 "	6¼	6¼	158.12 "	158	172
" 627*	6.281 "	6¼	6¾	159.54 "	160	175
" 874*	6.375 "	6¼	6¾	161.93 "	162	178
" 439*	6.475 "	6½	7	164.47 "	165	180
" 628*	6.563 "	6½	7¼	166.69 "	166	181
" 876*	6.625 "	6½	7¼	168.28 "	168	182
" 440*	6.725 "	6¾	7¼	170.82 "	170	185
" 878*	6.875 "	6¾	7¾	174.63 "	175	190
" 441*	6.975 "	7	7½	177.17 "	177	192
" 880*	7.125 ±0.045	7¼	7¾	180.98 ±1.14	180	195
" 442*	7.225 "	7¼	7¾	183.52 "	183	200
" 882*	7.375 "	7½	7¾	187.33 "	187	202
" 443*	7.475 "	7½	8	189.87 "	190	205
" 884*	7.625 "	7¾	8¼	193.68 "	193	208
" 444*	7.725 "	7¾	8¼	196.22 "	195	210
" 886*	7.875 "	7¾	8¾	200.03 "	200	215

James Walker Number	INCH DIAMETERS				METRIC DIAMETERS (mm)		
	Inside Dia. B	C, P, T	D, Q	Inside Dia. B	Shaft C	Cyl. D	
0.275 ±0.006" (6.99 ±0.15mm) Diameter Section A							
" 445*	7.975	±0.045	8	8½	202.57 ±1.14	202	220
" 445A	8.225	±0.055	8¼	8¾	208.92 ±1.40	208	225
" 446	8.475	"	8½	9	215.27 "	215	230
" 446A	8.725	"	8¾	9¼	221.62 "	220	240
" 447	8.975	"	9	9½	227.97 "	225	245
" 447A	9.225	"	9¼	9¾	234.32 "	235	250
" 448	9.475	"	9½	10	240.67 "	240	260
" 448A	9.725	"	9¾	10¼	247.02 "	245	265
" 449	9.975	"	10	10½	253.37 "	250	270
" 449A	10.225	±0.060	10¼	10¾	259.72 ±1.52	260	275
" 450	10.475	"	10½	11	266.07 "	265	280
" 450A	10.725	"	10¾	11¼	272.42 "	270	290
" 451	10.975	"	11	11½	278.77 "	275	295
" 451A	11.225	"	11¼	11¾	285.12 "	285	300
" 452	11.475	"	11½	12	291.47 "	290	310
" 452A	11.725	"	11¾	12¼	297.82 "	295	315
" 453	11.975	"	12	12½	304.17 "	300	320
" 648	12.225	"	12¼	12¾	310.52 "	310	325
" 454	12.475	"	12½	13	316.87 "	315	330
" 649	12.725	"	12¾	13¼	323.22 "	320	340
" 455	12.975	"	13	13½	329.57 "	330	345
" 650	13.225	±0.070	13¼	13¾	335.92 ±1.78	335	350
" 456	13.475	"	13½	14	342.27 "	340	360
" 457	13.975	"	14	14½	354.97 "	350	370
" 458	14.475	"	14½	15	367.67 "	365	385
" 459	14.975	"	15	15½	380.37 "	380	400
" 460	15.475	"	15½	16	393.07 "	390	410
" 461	15.955 ±0.075	"	16	16½	405.26 ±1.91	400	420
" 462	16.455	"	16½	17	417.96 "	415	435
" 463	16.955 ±0.080	"	17	17½	430.66 ±2.03	430	450
" 464	17.455 ±0.085	"	17½	18	443.36 ±2.16	440	460
" 465	17.955 "	"	18	18½	456.06 "	455	470
" 466	18.455 "	"	18½	19	468.76 "	465	485
" 467	18.955 ±0.090	"	19	19½	481.46 ±2.29	480	500
" 468	19.455 "	"	19½	20	494.16 "	495	510
" 469	19.955 ±0.095	"	20	20½	506.86 ±2.41	505	525
" 470	20.955 "	"	21	21½	532.26 "	530	550
" 471	21.955 ±0.100	"	22	22½	557.66 ±2.54	555	575
" 472	22.940 ±0.105	"	23	23½	582.68 ±2.67	580	600
" 473	23.940 ±0.110	"	24	24½	608.08 ±2.79	605	625
" 474	24.940 ±0.115	"	25	25½	633.48 ±2.92	630	650
" 475	25.940 ±0.120	"	26	26½	658.88 ±3.05	655	675

'O' rings for pipe fittings

The chart below gives details of 'O' rings for use with inch Unified Standard threads. The sizes are specified in SAE AS 568: Aerospace Size Standard for 'O' rings.

James Walker Number	INCH SIZES		METRIC CONVERSIONS (mm)	
	Diameter Section A	Inside Diameter B	Diameter Section A	Inside Diameter B
50-901	0.056 ±0.003	0.185 ±0.005	1.42 ±0.08	4.70 ±0.13
" 902	0.064 "	0.239 "	1.63 "	6.07 "
" 903	0.064 "	0.301 "	1.63 "	7.65 "
" 904	0.072 "	0.351 "	1.83 "	8.92 "
" 905	0.072 "	0.414 "	1.83 "	10.52 "
" 906	0.078 "	0.468 "	1.98 "	11.89 "
" 907	0.082 "	0.530 ±0.007	2.08 "	13.46 ±0.18
" 908	0.087 "	0.644 ±0.009	2.21 "	16.36 ±0.23
" 909	0.097 "	0.706 "	2.46 "	17.93 "
" 910	0.097 "	0.755 "	2.46 "	19.18 "
" 911	0.116 ±0.004	0.863 "	2.95 ±0.10	21.92 "
" 912	0.116 "	0.924 "	2.95 "	23.47 "
" 913	0.116 "	0.986 ±0.010	2.95 "	25.04 ±0.25
" 914	0.116 "	1.047 "	2.95 "	26.59 "
" 916	0.116 "	1.171 "	2.95 "	29.74 "
" 918	0.116 "	1.355 ±0.012	2.95 "	34.42 ±0.30
" 920	0.118 "	1.475 ±0.014	3.00 "	37.47 ±0.36
" 924	0.118 "	1.720 "	3.00 "	43.69 "
" 928	0.118 "	2.090 ±0.018	3.00 "	53.09 ±0.46
" 932	0.118 "	2.337 "	3.00 "	59.36 "

Aerospace sizes to BS ISO 3601-1

BS ISO 3601-1 'O' rings for aerospace applications use housings identified in BS EN 3748 Aerospace series 'O' ring grooves: Dimensions. Please contact our Technical Support Team for advice.

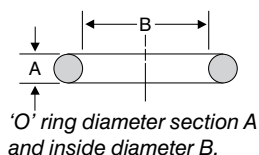

BS ISO 3601-1 Size code	Size B A (mm)	INSIDE DIAMETER			
		B nom. (mm)	Tolerance (mm)	B nom. (in)	Tolerance (in)
1.80 mm ± 0.08 mm (0.071 in ± 0.003 in) Diameter Section A					
A0018	1.8 x 1.8	1.80	±0.13	0.071	±0.005
A0020	2 x 1.8	2.00	"	0.079	"
A0022	2.24 x 1.8	2.24	"	0.088	"
A0025	2.5 x 1.8	2.50	"	0.098	"
A0028	2.8 x 1.8	2.80	"	0.110	"
A0032	3.15 x 1.8	3.15	"	0.124	"
A0036	3.55 x 1.8	3.55	"	0.140	"
A0038	3.75 x 1.8	3.75	"	0.148	"
A0040	4 x 1.8	4.00	"	0.157	"
A0450	4.5 x 1.8	4.50	"	0.177	"
A0490	4.87 x 1.8	4.87	"	0.192	"
A0050	5 x 1.8	5.00	"	0.197	"
A0052	5.2 x 1.8	5.20	"	0.205	"
A0053	5.3 x 1.8	5.30	"	0.209	"
A0056	5.6 x 1.8	5.60	"	0.220	"
A0060	6 x 1.8	6.00	"	0.236	"
A0063	6.3 x 1.8	6.30	"	0.248	"
A0067	6.7 x 1.8	6.70	"	0.264	"
A0069	6.9 x 1.8	6.90	±0.14	0.272	±0.006
A0071	7.1 x 1.8	7.10	"	0.280	"
A0075	7.5 x 1.8	7.50	"	0.295	"
A0080	8 x 1.8	8.00	"	0.315	"
A0085	8.5 x 1.8	8.50	±0.15	0.335	"
A0088	8.75 x 1.8	8.75	"	0.344	"
A0090	9 x 1.8	9.00	"	0.354	"
A0095	9.5 x 1.8	9.50	"	0.374	"
A0100	10 x 1.8	10.00	"	0.394	"
A0106	10.6 x 1.8	10.60	±0.16	0.417	"
A0112	11.2 x 1.8	11.20	"	0.441	"
A0118	11.8 x 1.8	11.80	±0.17	0.465	±0.007
A0125	12.5 x 1.8	12.50	"	0.492	"
A0132	13.2 x 1.8	13.20	"	0.520	"
A0140	14 x 1.8	14.00	±0.18	0.551	"
A0150	15 x 1.8	15.00	"	0.591	"
A0160	16 x 1.8	16.00	±0.19	0.630	"
A0170	17 x 1.8	17.00	±0.20	0.669	±0.008
A0180	18 x 1.8	18.00	"	0.709	"
A0190	19 x 1.8	19.00	±0.21	0.748	"
A0200	20 x 1.8	20.00	"	0.787	"
A0212	21.2 x 1.8	21.20	±0.22	0.835	±0.009
A0224	22.4 x 1.8	22.40	±0.23	0.882	"
A0236	23.6 x 1.8	23.60	±0.24	0.929	"
A0250	25 x 1.8	25.00	"	0.984	"
A0258	25.8 x 1.8	25.80	±0.25	1.016	±0.010
A0265	26.5 x 1.8	26.50	"	1.043	"
A0280	28 x 1.8	28.00	±0.26	1.102	"
A0300	30 x 1.8	30.00	"	1.181	"
A0315	31.5 x 1.8	31.50	±0.28	1.240	±0.011
A0325	32.5 x 1.8	32.50	±0.29	1.280	"
A0335	33.5 x 1.8	33.50	"	1.319	"

BS ISO 3601-1 Size code	Size B A (mm)	INSIDE DIAMETER			
		B nom. (mm)	Tolerance (mm)	B nom. (in)	Tolerance (in)
1.80 mm ± 0.08 mm (0.071 in ± 0.003 in) Diameter Section A					
A0345	34.5 x 1.8	34.50	±0.30	1.358	±0.012
A0355	35.5 x 1.8	35.50	±0.31	1.398	"
A0365	36.5 x 1.8	36.50	"	1.437	"
A0375	37.5 x 1.8	37.50	±0.32	1.476	±0.013
A0387	38.7 x 1.8	38.70	"	1.524	"
A0400	40 x 1.8	40.00	±0.33	1.575	"
A0412	41.2 x 1.8	41.20	±0.34	1.622	"
A0425	42.5 x 1.8	42.50	±0.35	1.673	±0.014
A0437	43.7 x 1.8	43.70	"	1.720	"
A0450	45 x 1.8	45.00	±0.36	1.772	"
A0475	47.5 x 1.8	47.50	±0.38	1.870	±0.015
A0500	50 x 1.8	50.00	±0.39	1.969	"
A0530	53 x 1.8	53.00	±0.41	2.087	±0.016
A0560	56 x 1.8	56.00	±0.42	2.205	±0.017
A0600	60 x 1.8	60.00	±0.45	2.362	±0.018
A0630	63 x 1.8	63.00	±0.46	2.480	"
A0670	67 x 1.8	67.00	±0.49	2.638	±0.019
A0710	71 x 1.8	71.00	±0.51	2.795	±0.020
A0750	75 x 1.8	75.00	±0.53	2.953	±0.021
A0800	80 x 1.8	80.00	±0.56	3.150	±0.022
A0850	85 x 1.8	85.00	±0.59	3.346	±0.023
A0900	90 x 1.8	90.00	±0.62	3.543	±0.024
A0950	95 x 1.8	95.00	±0.64	3.740	±0.025
A1000	100 x 1.8	100.00	±0.67	3.937	±0.026
A1060	106 x 1.8	106.00	±0.71	4.173	±0.028
A1120	112 x 1.8	112.00	±0.74	4.409	±0.029
A1180	118 x 1.8	118.00	±0.77	4.646	±0.030
A1250	125 x 1.8	125.00	±0.81	4.921	±0.032
2.65 mm ± 0.09 mm (0.104 in ± 0.004 in) Diameter Section A					
B0045	4.5 x 2.65	4.50	±0.13	0.177	±0.005
B0053	5.3 x 2.65	5.30	"	0.209	"
B0060	6 x 2.65	6.00	"	0.236	"
B0069	6.9 x 2.65	6.90	±0.14	0.272	±0.006
B0080	8 x 2.65	8.00	"	0.315	"
B0090	9 x 2.65	9.00	±0.15	0.354	"
B0095	9.5 x 2.65	9.50	"	0.374	"
B0100	10 x 2.65	10.00	"	0.394	"
B0106	10.6 x 2.65	10.60	±0.16	0.417	"
B0112	11.2 x 2.65	11.20	"	0.441	"
B0118	11.8 x 2.65	11.80	±0.17	0.465	±0.007
B0125	12.5 x 2.65	12.50	"	0.492	"
B0132	13.2 x 2.65	13.20	"	0.520	"
B0140	14 x 2.65	14.00	±0.18	0.551	"
B0150	15 x 2.65	15.00	"	0.591	"
B0160	16 x 2.65	16.00	±0.19	0.630	"
B0170	17 x 2.65	17.00	±0.20	0.669	±0.008
B0180	18 x 2.65	18.00	"	0.709	"
B0190	19 x 2.65	19.00	±0.21	0.748	"
B0200	20 x 2.65	20.00	"	0.787	"
B0212	21.2 x 2.65	21.20	±0.22	0.835	±0.009
B0224	22.4 x 2.65	22.40	±0.23	0.882	"
B0236	23.6 x 2.65	23.60	±0.24	0.929	"
B0250	25 x 2.65	25.00	"	0.984	"
B0258	25.8 x 2.65	25.80	±0.25	1.016	±0.010
B0265	26.5 x 2.65	26.50	"	1.043	"
B0280	28 x 2.65	28.00	±0.26	1.102	"
B0300	30 x 2.65	30.00	±0.27	1.181	±0.011
B0315	31.5 x 2.65	31.50	±0.28	1.240	"

Aerospace sizes to BS ISO 3601-1

BS ISO 3601-1 Size code	Size B A (mm)	INSIDE DIAMETER			
		B nom. (mm)	Tolerance (mm)	B nom. (in)	Tolerance (in)
2.65 mm ± 0.09 mm (0.104 in ±0.004 in) Diameter Section A					
B0325	32.5 x 2.65	32.50	±0.29	1.280	±0.011
B0335	33.5 x 2.65	33.50	"	1.319	"
B0345	34.5 x 2.65	34.50	±0.30	1.358	±0.012
B0355	35.5 x 2.65	35.50	±0.31	1.398	"
B0365	36.5 x 2.65	36.50	"	1.437	"
B0375	37.5 x 2.65	37.50	±0.32	1.476	±0.013
B0387	38.7 x 2.65	38.70	"	1.524	"
B0400	40 x 2.65	40.00	±0.33	1.575	"
B0412	41.2 x 2.65	41.20	±0.34	1.622	±0.013
B0425	42.5 x 2.65	42.50	±0.35	1.673	±0.014
B0437	43.7 x 2.65	43.70	"	1.720	"
B0450	45 x 2.65	45.00	±0.36	1.772	"
B0462	46.2 x 2.65	46.20	±0.37	1.819	±0.015
B0475	47.5 x 2.65	47.50	±0.38	1.870	"
B0487	48.7 x 2.65	48.70	"	1.917	"
B0500	50 x 2.65	50.00	±0.39	1.969	"
B0515	51.5 x 2.65	51.50	±0.40	2.028	±0.016
B0530	53 x 2.65	53.00	±0.41	2.087	"
B0545	54.5 x 2.65	54.50	±0.42	2.146	±0.017
B0560	56 x 2.65	56.00	"	2.205	"
B0580	58 x 2.65	58.00	±0.44	2.283	"
B0600	60 x 2.65	60.00	±0.45	2.362	±0.018
B0615	61.5 x 2.65	61.50	"	2.421	"
B0630	63 x 2.65	63.00	±0.46	2.480	"
B0650	65 x 2.65	65.00	±0.48	2.559	±0.019
B0670	67 x 2.65	67.00	±0.49	2.638	"
B0690	69 x 2.65	69.00	±0.50	2.717	±0.020
B0710	71 x 2.65	71.00	±0.51	2.795	"
B0730	73 x 2.65	73.00	±0.52	2.874	"
B0750	75 x 2.65	75.00	±0.53	2.953	±0.021
B0800	80 x 2.65	80.00	±0.56	3.150	±0.022
B0850	85 x 2.65	85.00	±0.59	3.346	±0.023
B0900	90 x 2.65	90.00	±0.62	3.543	±0.024
B0950	95 x 2.65	95.00	±0.64	3.740	±0.025
B1000	100 x 2.65	100.00	±0.67	3.937	±0.026
B1060	106 x 2.65	106.00	±0.71	4.173	±0.028
B1120	112 x 2.65	112.00	±0.74	4.409	±0.029
B1180	118 x 2.65	118.00	±0.77	4.646	±0.030
B1250	125 x 2.65	125.00	±0.81	4.921	±0.032
B1320	132 x 2.65	132.00	±0.85	5.197	±0.033
B1400	140 x 2.65	140.00	±0.89	5.512	±0.035
B1500	150 x 2.65	150.00	±0.95	5.906	±0.037
B1600	160 x 2.65	160.00	±1.00	6.299	±0.039
B1700	170 x 2.65	170.00	±1.06	6.693	±0.042
B1800	180 x 2.65	180.00	±1.11	7.087	±0.044
B1900	190 x 2.65	190.00	±1.17	7.480	±0.046
B2000	200 x 2.65	200.00	±1.22	7.874	±0.048
B2120	212 x 2.65	212.00	±1.29	8.346	±0.051
B2240	224 x 2.65	224.00	±1.35	8.819	±0.053
B2300	230 x 2.65	230.00	±1.39	9.055	±0.055
B2360	236 x 2.65	236.00	±1.42	9.291	±0.056
B2430	243 x 2.65	243.00	±1.46	9.567	±0.057
B2500	250 x 2.65	250.00	±1.49	9.843	±0.059

BS ISO 3601-1 Size code	Size B A (mm)	INSIDE DIAMETER			
		B nom. (mm)	Tolerance (mm)	B nom. (in)	Tolerance (in)
3.55 mm ± 0.10 mm (0.140 in ±0.004 in) Diameter Section A					
C0140	14 x 3.55	14.00	±0.18	0.551	±0.007
C0150	15 x 3.55	15.00	"	0.591	"
C0160	16 x 3.55	16.00	±0.19	0.630	"
C0170	17 x 3.55	17.00	±0.20	0.669	±0.008
C0180	18 x 3.55	18.00	"	0.709	"
C0190	19 x 3.55	19.00	±0.21	0.748	"
C0200	20 x 3.55	20.00	"	0.787	"
C0212	21.2 x 3.55	21.20	±0.22	0.835	±0.009
C0224	22.4 x 3.55	22.40	±0.23	0.882	"
C0236	23.6 x 3.55	23.60	±0.24	0.929	"
C0250	25 x 3.55	25.00	"	0.984	"
C0258	25.8 x 3.55	25.80	±0.25	1.016	±0.010
C0265	26.5 x 3.55	26.50	"	1.043	"
C0280	28 x 3.55	28.00	±0.26	1.102	"
C0300	30 x 3.55	30.00	±0.27	1.181	±0.011
C0315	31.5 x 3.55	31.50	±0.28	1.240	"
C0325	32.5 x 3.55	32.50	±0.29	1.280	"
C0335	33.5 x 3.55	33.50	"	1.319	"
C0345	34.5 x 3.55	34.50	±0.30	1.358	±0.012
C0355	35.5 x 3.55	35.50	±0.31	1.398	"
C0365	36.5 x 3.55	36.50	"	1.437	"
C0375	37.5 x 3.55	37.50	±0.32	1.476	"
C0387	38.7 x 3.55	38.70	"	1.524	±0.013
C0400	40 x 3.55	40.00	±0.33	1.575	"
C0412	41.2 x 3.55	41.20	±0.34	1.622	"
C0425	42.5 x 3.55	42.50	±0.35	1.673	±0.014
C0437	43.7 x 3.55	43.70	"	1.720	"
C0450	45 x 3.55	45.00	±0.36	1.772	"
C0462	46.2 x 3.55	46.20	±0.37	1.819	±0.015
C0475	47.5 x 3.55	47.50	±0.38	1.870	"
C0487	48.7 x 3.55	48.70	"	1.917	"
C0500	50 x 3.55	50.00	±0.39	1.969	"
C0515	51.5 x 3.55	51.50	±0.40	2.028	±0.016
C0530	53 x 3.55	53.00	±0.41	2.087	"
C0545	54.5 x 3.55	54.50	±0.42	2.146	±0.017
C0560	56 x 3.55	56.00	"	2.205	"
C0580	58 x 3.55	58.00	±0.44	2.283	"
C0600	60 x 3.55	60.00	±0.45	2.362	±0.018
C0615	61.5 x 3.55	61.50	"	2.421	"
C0630	63 x 3.55	63.00	±0.46	2.480	"
C0650	65 x 3.55	65.00	±0.48	2.559	±0.019
C0670	67 x 3.55	67.00	±0.49	2.638	"
C0690	69 x 3.55	69.00	±0.50	2.717	±0.020
C0710	71 x 3.55	71.00	±0.51	2.795	"
C0730	73 x 3.55	73.00	±0.52	2.874	"
C0750	75 x 3.55	75.00	±0.53	2.953	±0.021
C0775	77.5 x 3.55	77.50	±0.55	3.051	±0.022
C0800	80 x 3.55	80.00	±0.56	3.150	"
C0825	82.5 x 3.55	82.50	±0.57	3.248	"
C0850	85 x 3.55	85.00	±0.59	3.346	±0.023
C0875	87.5 x 3.55	87.50	±0.60	3.445	±0.024
C0900	90 x 3.55	90.00	±0.62	3.543	"
C0925	92.5 x 3.55	92.50	±0.63	3.642	±0.025
C0950	95 x 3.55	95.00	±0.64	3.740	"
C0975	97.5 x 3.55	97.50	±0.66	3.839	±0.026
C1000	100 x 3.55	100.00	±0.67	3.937	"

Aerospace sizes to BS ISO 3601-1

BS ISO 3601-1 Size code	Size B A (mm)	INSIDE DIAMETER			
		B nom. (mm)	Tolerance (mm)	B nom. (in)	Tolerance (in)
3.55mm ± 0.10 mm (0.140 in ±0.004 in) Diameter Section A					
C1030	103 x 3.55	103.00	±0.69	4.055	±0.027
C1060	106 x 3.55	106.00	±0.71	4.173	±0.028
C1090	109 x 3.55	109.00	±0.72	4.291	"
C1120	112 x 3.55	112.00	±0.74	4.409	±0.029
C1150	115 x 3.55	115.00	±0.76	4.528	±0.030
C1180	118 x 3.55	118.00	±0.77	4.646	"
C1220	122 x 3.55	122.00	±0.80	4.803	±0.031
C1250	125 x 3.55	125.00	±0.81	4.921	±0.032
C1280	128 x 3.55	128.00	±0.83	5.039	±0.033
C1320	132 x 3.55	132.00	±0.85	5.197	"
C1360	136 x 3.55	136.00	±0.87	5.354	±0.034
C1400	140 x 3.55	140.00	±0.89	5.512	±0.035
C1450	145 x 3.55	145.00	±0.92	5.709	±0.036
C1500	150 x 3.55	150.00	±0.95	5.906	±0.037
C1550	155 x 3.55	155.00	±0.98	6.102	±0.039
C1600	160 x 3.55	160.00	±1.00	6.299	"
C1650	165 x 3.55	165.00	±1.03	6.496	±0.041
C1700	170 x 3.55	170.00	±1.06	6.693	±0.042
C1750	175 x 3.55	175.00	±1.09	6.890	±0.043
C1800	180 x 3.55	180.00	±1.11	7.087	±0.044
C1850	185 x 3.55	185.00	±1.14	7.283	±0.045
C1900	190 x 3.55	190.00	±1.17	7.480	±0.046
C1950	195 x 3.55	195.00	±1.20	7.677	±0.047
C2000	200 x 3.55	200.00	±1.22	7.874	±0.048
C2120	212 x 3.55	212.00	±1.29	8.346	±0.051
C2180	218 x 3.55	218.00	±1.32	8.523	±0.052
C2240	224 x 3.55	224.00	±1.35	8.819	±0.053
C2300	230 x 3.55	230.00	±1.39	9.055	±0.055
C2360	236 x 3.55	236.00	±1.42	9.291	±0.056
C2500	250 x 3.55	250.00	±1.49	9.843	±0.059
C2580	258 x 3.55	258.00	±1.54	10.157	±0.061
C2650	265 x 3.55	265.00	±1.57	10.433	±0.062
C2800	280 x 3.55	280.00	±1.65	11.024	±0.065
C2900	290 x 3.55	290.00	±1.71	11.417	±0.067
C3000	300 x 3.55	300.00	±1.76	11.811	±0.069
C3070	307 x 3.55	307.00	±1.80	12.087	±0.071
C3150	315 x 3.55	315.00	±1.84	12.402	±0.072
C3350	335 x 3.55	335.00	±1.95	13.189	±0.077
C3550	355 x 3.55	355.00	±2.06	13.976	±0.081

5.30 mm ± 0.13 mm (0.209 in ±0.005 in) Diameter Section A					
D0375	37.5 x 5.3	37.50	±0.32	1.476	±0.012
D0387	38.7 x 5.3	38.70	"	1.524	±0.013
D0400	40 x 5.3	40.00	±0.33	1.575	"
D0412	41.2 x 5.3	41.20	±0.34	1.622	"
D0425	42.5 x 5.3	42.50	±0.35	1.673	±0.014
D0437	43.7 x 5.3	43.70	"	1.720	"
D0450	45 x 5.3	45.00	±0.36	1.772	"
D0462	46.2 x 5.3	46.20	±0.37	1.819	±0.015
D0475	47.5 x 5.3	47.50	±0.38	1.870	"
D0487	48.7 x 5.3	48.70	"	1.917	"
D0500	50 x 5.3	50.00	±0.39	1.969	"
D0515	51.5 x 5.3	51.50	±0.40	2.028	±0.016
D0530	53 x 5.3	53.00	±0.41	2.087	"
D0545	54.5 x 5.3	54.50	±0.42	2.146	±0.017
D0560	56 x 5.3	56.00	"	2.205	"
D0580	58 x 5.3	58.00	±0.44	2.283	"
D0600	60 x 5.3	60.00	±0.45	2.362	±0.018
D0615	61.5 x 5.3	61.50	"	2.421	"

BS ISO 3601-1 Size code	Size B A (mm)	INSIDE DIAMETER			
		B nom. (mm)	Tolerance (mm)	B nom. (in)	Tolerance (in)
5.30mm ± 0.13 mm (0.209 in ±0.005 in) Diameter Section A					
D0630	63 x 5.3	63.00	±0.46	2.480	±0.018
D0650	65 x 5.3	65.00	±0.48	2.559	±0.019
D0670	67 x 5.3	67.00	±0.49	2.638	"
D0690	69 x 5.3	69.00	±0.50	2.717	±0.020
D0710	71 x 5.3	71.00	±0.51	2.795	"
D0730	73 x 5.3	73.00	±0.52	2.874	"
D0750	75 x 5.3	75.00	±0.53	2.953	±0.021
D0775	77.5 x 5.3	77.50	±0.55	3.051	±0.022
D0800	80 x 5.3	80.00	±0.56	3.150	"
D0825	82.5 x 5.3	82.50	±0.57	3.248	"
D0850	85 x 5.3	85.00	±0.59	3.346	±0.023
D0875	87.5 x 5.3	87.50	±0.60	3.445	±0.024
D0900	90 x 5.3	90.00	±0.62	3.543	"
D0925	92.5 x 5.3	92.50	±0.63	3.642	±0.025
D0950	95 x 5.3	95.00	±0.64	3.740	"
D0975	97.5 x 5.3	97.50	±0.66	3.839	±0.026
D1000	100 x 5.3	100.00	±0.67	3.937	"
D1030	103 x 5.3	103.00	±0.69	4.055	±0.027
D1060	106 x 5.3	106.00	±0.71	4.173	±0.028
D1090	109 x 5.3	109.00	±0.72	4.291	"
D1120	112 x 5.3	112.00	±0.74	4.409	±0.029
D1150	115 x 5.3	115.00	±0.76	4.528	±0.030
D1180	118 x 5.3	118.00	±0.77	4.646	"
D1220	122 x 5.3	122.00	±0.80	4.803	±0.031
D1250	125 x 5.3	125.00	±0.81	4.921	±0.032
D1280	128 x 5.3	128.00	±0.83	5.039	±0.033
D1320	132 x 5.3	132.00	±0.85	5.197	"
D1360	136 x 5.3	136.00	±0.87	5.354	±0.034
D1400	140 x 5.3	140.00	±0.89	5.512	±0.035
D1450	145 x 5.3	145.00	±0.92	5.709	±0.036
D1500	150 x 5.3	150.00	±0.95	5.906	±0.037
D1550	155 x 5.3	155.00	±0.98	6.102	±0.039
D1600	160 x 5.3	160.00	±1.00	6.299	"
D1650	165 x 5.3	165.00	±1.03	6.496	±0.041
D1700	170 x 5.3	170.00	±1.06	6.693	±0.042
D1750	175 x 5.3	175.00	±1.09	6.890	±0.043
D1800	180 x 5.3	180.00	±1.11	7.087	±0.044
D1850	185 x 5.3	185.00	±1.14	7.283	±0.045
D1900	190 x 5.3	190.00	±1.17	7.480	±0.046
D1950	195 x 5.3	195.00	±1.20	7.677	±0.047
D2000	200 x 5.3	200.00	±1.22	7.874	±0.048

7.00 mm ± 0.15 mm (0.276 in ±0.006 in) Diameter Section A					
E1090	109 x 7	109.00	±0.72	4.291	±0.028
E1120	112 x 7	112.00	±0.74	4.409	±0.029
E1150	115 x 7	115.00	±0.76	4.528	±0.030
E1180	118 x 7	118.00	±0.77	4.646	"
E1220	122 x 7	122.00	±0.80	4.803	±0.031
E1250	125 x 7	125.00	±0.81	4.921	±0.032
E1280	128 x 7	128.00	±0.83	5.039	±0.033
E1320	132 x 7	132.00	±0.85	5.197	"
E1360	136 x 7	136.00	±0.87	5.354	±0.034
E1400	140 x 7	140.00	±0.89	5.512	±0.035
E1450	145 x 7	145.00	±0.92	5.709	±0.036
E1500	150 x 7	150.00	±0.95	5.906	±0.037
E1550	155 x 7	155.00	±0.98	6.102	±0.039
E1600	160 x 7	160.00	±1.00	6.299	"

Aerospace sizes to BS ISO 3601-1

BS ISO 3601-1 Size code	Size B A (mm)	INSIDE DIAMETER			
		B nom. (mm)	Tolerance (mm)	B nom. (in)	Tolerance (in)
7.00 mm ± 0.15 mm (0.276 in ± 0.006 in) Diameter Section A					
E1650	165 x 7	165.00	±1.03	6.496	±0.041
E1700	170 x 7	170.00	±1.06	6.693	±0.042
E1750	175 x 7	175.00	±1.09	6.890	±0.043
E1800	180 x 7	180.00	±1.11	7.087	±0.044
E1850	185 x 7	185.00	±1.14	7.283	±0.045
E1900	190 x 7	190.00	±1.17	7.480	±0.046
E1950	195 x 7	195.00	±1.20	7.677	±0.047
E2000	200 x 7	200.00	±1.22	7.874	±0.048
E2060	206 x 7	206.00	±1.26	8.110	±0.050
E2120	212 x 7	212.00	±1.29	8.346	±0.051
E2180	218 x 7	218.00	±1.32	8.523	±0.052
E2240	224 x 7	224.00	±1.35	8.819	±0.053
E2300	230 x 7	230.00	±1.39	9.055	±0.055
E2360	236 x 7	236.00	±1.42	9.291	±0.056
E2430	243 x 7	243.00	±1.46	9.567	±0.057
E2500	250 x 7	250.00	±1.49	9.843	±0.059
E2580	258 x 7	258.00	±1.54	10.157	±0.061
E2650	265 x 7	265.00	±1.57	10.433	±0.062
E2720	272 x 7	272.00	±1.61	10.709	±0.063
E2800	280 x 7	280.00	±1.65	11.024	±0.065
E2900	290 x 7	290.00	±1.71	11.417	±0.067
E3000	300 x 7	300.00	±1.76	11.811	±0.069
E3070	307 x 7	307.00	±1.80	12.087	±0.071
E3150	315 x 7	315.00	±1.84	12.402	±0.072
E3250	325 x 7	325.00	±1.90	12.795	±0.075
E3350	335 x 7	335.00	±1.95	13.189	±0.077
E3450	345 x 7	345.00	±2.00	13.583	±0.079
E3550	355 x 7	355.00	±2.06	13.976	±0.081
E3650	365 x 7	365.00	±2.11	14.370	±0.083
E3750	375 x 7	375.00	±2.16	14.764	±0.085
E3870	387 x 7	387.00	±2.23	15.236	±0.088
E4000	400 x 7	400.00	±2.29	15.748	±0.090

BS ISO 3601-1 'O' rings for aerospace applications use housings identified in BS EN 3748 *Aerospace series 'O' ring grooves: Dimensions*. Please contact our Technical Support Team for advice.

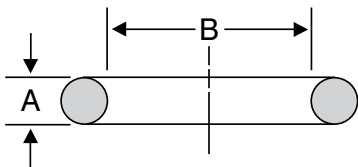

'O' ring diameter section A and inside diameter B.



Chart 72: metric sizes

James Walker Chart 72 covers:

- **BS 4518:** Metric dimensions of toroidal sealing rings (O rings) and their housings.

If the metric size you want is not available, please use the metric columns in **Chart 50** or **Aerospace sizes to BS ISO 3601-1**.

Chart 72 back-up rings cover sizes that include those in:

- **BS 5106:** Dimensions of spiral anti-extrusion back-up rings and their housings.

Pneumatic & static plug housing details to BS 4518			
For applications requiring back-up rings, use dynamic housing sizes on pages 30-31.			
	Pneumatic	Static plug	
Diameter section A (mm)	Radial depth F (mm)	Groove width E (mm) 'O' ring only	Radial depth F (mm)
2.4	2.13 / 2.20	3.1 / 3.3	1.84 / 1.97
3.0	2.70 / 2.77	3.7 / 3.9	2.35 / 2.50
4.1	3.73 / 3.82	5.0 / 5.2	3.30 / 3.45
5.7	5.22 / 5.38	6.4 / 6.6	4.70 / 4.95
8.4	7.75 / 7.96	9.0 / 9.2	7.20 / 7.50

For flange applications, the values of groove inside and outside diameters (V and W — see Figure 11 on page 29) are shown on **Chart 72**.

BS EN ISO 286-2 tolerances H11, h11 are given on page 31.

Housing details can be referred to on pages 29-31.

*** Static/dynamic applications**

An asterisk symbol (*) denotes that the ring is suitable for both dynamic and static applications. Other sizes are not recommended for dynamic duties.

All **Chart 72** dimensions are in millimetres (mm).

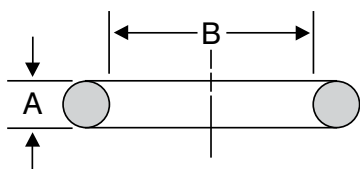

'O' ring diameter section A and inside diameter B.

Refer to page 29 for List of Symbols

James Walker Number	Diameters			Flange Groove Diameters			
	Inside Dia. B	C, T	Cyl. D	Internal Pressure		External Pressure	
				V max	W (H11)	V (h11)	W min
1.6 ±0.08mm Diameter Section A							
72-0031-16	3.1 ±0.15	3.5	6	1.0	6.3	3.5	7.5
" 0041-16	4.1 "	4.5	7	2.3	7.3	4.5	8.5
" 0051-16	5.1 "	5.5	8	3.3	8.3	5.5	9.5
" 0061-16	6.1 "	6.5	9	4.3	9.3	6.5	10.5
" 0071-16	7.1 "	7.5	10	5.8	10.3	7.5	11.5
" 0081-16	8.1 "	8.5	11	6.8	11.3	8.5	12.5
" 0091-16	9.1 "	9.5	12	7.8	12.3	9.5	13.5
" 0101-16	10.1 ±0.20	10.5	13	8.8	13.3	10.5	14.5
" 0111-16	11.1 "	11.5	14	9.8	14.3	11.5	15.5
" 0121-16	12.1 "	12.5	15	10.8	15.3	12.5	16.5
" 0131-16	13.1 "	13.5	16	11.8	16.3	13.5	17.5
" 0141-16	14.1 "	14.5	17	12.8	17.3	14.5	18.5
" 0151-16	15.1 "	15.5	18	14.0	18.3	15.5	19.5
" 0161-16	16.1 "	16.5	19	15	19.3	16.5	20.5
" 0171-16	17.1 "	17.5	20	16	20.3	17.5	21.5
" 0181-16	18.1 ±0.25	18.5	21	17	21.3	18.5	22.5
" 0191-16	19.1 "	19.5	22	18	22.3	19.5	23.5
" 0221-16	22.1 "	22.5	25	21	25.3	22.5	26.5
" 0251-16	25.1 "	25.5	28	24	28.3	25.5	29.5
" 0271-16	27.1 "	27.5	30	26	30.3	27.5	31.5
" 0291-16	29.1 "	29.5	32	28	32.3	29.5	33.5
" 0321-16	32.1 ±0.30	32.5	35	31	35.3	32.5	36.5
" 0351-16	35.1 "	35.5	38	34	38.3	35.5	39.5
" 0371-16	37.1 "	37.5	40	36	40.3	37.5	41.5
2.4 ±0.08mm Diameter Section A							
72-0036-24*	3.6 ±0.15	4	8	-	8.4	4	10
" 0046-24*	4.6 "	5	9	1.0	9.4	5	11
" 0056-24*	5.6 "	6	10	2.5	10.4	6	12
" 0066-24*	6.6 "	7	11	4.0	11.4	7	13
" 0076-24*	7.6 "	8	12	5.0	12.4	8	14
" 0086-24*	8.6 "	9	13	6.4	13.4	9	15
" 0096-24*	9.6 "	10	14	7.4	14.4	10	16
" 0106-24*	10.6 ±0.20	11	15	8.4	15.4	11	17
" 0116-24*	11.6 "	12	16	9.5	16.4	12	18
" 0126-24*	12.6 "	13	17	10.5	17.4	13	19
" 0136-24*	13.6 "	14	18	11.5	18.4	14	20
" 0146-24*	14.6 "	15	19	12.5	19.4	15	21
" 0156-24*	15.6 "	16	20	13.5	20.4	16	22
" 0166-24*	16.6 "	17	21	14.5	21.4	17	23
" 0176-24*	17.6 "	18	22	15.5	22.4	18	24
" 0186-24	18.6 ±0.25	19	23	16.5	23.4	19	25
" 0196-24	19.6 "	20	24	17.5	24.4	20	26
" 0206-24	20.6 "	21	25	18.5	25.4	21	27
" 0216-24	21.6 "	22	26	19.5	26.4	22	28
" 0246-24	24.6 "	25	29	22.5	29.4	25	31
" 0276-24	27.6 "	28	32	25.5	32.4	28	34
" 0296-24	29.6 "	30	34	27.5	34.4	30	36
" 0316-24	31.6 ±0.30	32	36	29.5	36.4	32	38
" 0346-24	34.6 "	35	39	32.5	39.4	35	41
" 0356-24	35.6 "	36	40	33.5	40.4	36	42
" 0376-24	37.6 "	38	42	35.5	42.4	38	44
" 0396-24	39.6 "	40	44	37.5	44.4	40	46
" 0416-24	41.6 "	42	46	39.5	46.4	42	48
" 0446-24	44.6 "	45	49	42.5	49.4	45	51
" 0456-24	45.6 "	46	50	43.5	50.4	46	52
" 0476-24	47.6 "	48	52	45.5	52.4	48	54
" 0496-24	49.6 "	50	54	47.5	54.4	50	56
" 0516-24	51.6 ±0.40	52	56	49.5	56.4	52	58
" 0546-24	54.6 "	55	59	52.5	59.4	55	61
" 0556-24	55.6 "	56	60	53.5	60.4	56	62
" 0576-24	57.6 "	58	62	55.5	62.4	58	64
" 0586-24	58.6 "	59	63	56.5	63.4	59	65
" 0596-24	59.6 "	60	64	57.5	64.4	60	66
" 0616-24	61.6 "	62	66	59.5	66.4	62	68
" 0626-24	62.6 "	63	67	60.5	67.4	63	69
" 0646-24	64.6 "	65	69	62.5	69.4	65	71
" 0676-24	67.6 "	68	72	65.5	72.4	68	74
" 0696-24	69.6 "	70	74	67.5	74.4	70	76

Chart 72: metric sizes

Refer to page 29 for List of Symbols

James Walker Number	Diameters			Flange Groove Diameters			
	Inside Dia. B	C, T	Cyl. D	Internal Pressure V max W (H11)		External Pressure V (h11) W min	
3.0 ±0.10mm Diameter Section A							
72-0195-30*	19.5 ±0.25	20	25	17	25	20	28
" 0215-30*	21.5 "	22	27	19	27	22	30
" 0225-30*	22.5 "	23	28	20	28	23	31
" 0245-30*	24.5 "	25	30	22	30	25	33
" 0255-30*	25.5 "	26	31	23	31	26	34
" 0265-30*	26.5 "	27	32	24	32	27	35
" 0275-30*	27.5 "	28	33	25	33	28	36
" 0295-30*	29.5 "	30	35	27	35	30	38
" 0315-30*	31.5 ±0.30	32	37	29	37	32	40
" 0325-30*	32.5 "	33	38	30	38	33	41
" 0345-30*	34.5 "	35	40	32	40	35	43
" 0355-30*	35.5 "	36	41	33	41	36	44
" 0365-30*	36.5 "	37	42	34	42	37	45
" 0375-30*	37.5 "	38	43	35	43	38	46
" 0395-30*	39.5 "	40	45	37	45	40	48
" 0415-30*	41.5 "	42	47	39	47	42	50
" 0425-30*	42.5 "	43	48	40	48	43	51
" 0445-30*	44.5 "	45	50	42	50	45	53
" 0495-30*	49.5 "	50	55	47	55	50	58
" 0545-30	54.5 ±0.40	55	60	52	60	55	63
" 0555-30	55.5 "	56	61	53	61	56	64
" 0575-30	57.5 "	58	63	55	63	58	66
" 0595-30	59.5 "	60	65	57	65	60	68
" 0625-30	62.5 "	63	68	60	68	63	71
" 0645-30	64.5 "	65	70	62	70	65	73
" 0695-30	69.5 "	70	75	67	75	70	78
" 0745-30	74.5 "	75	80	72	80	75	83
" 0795-30	79.5 "	80	85	77	85	80	88
" 0845-30	84.5 ±0.50	85	90	82	90	85	93
" 0895-30	89.5 "	90	95	87	95	90	98
" 0945-30	94.5 "	95	100	92	100	95	103
" 0995-30	99.5 "	100	105	97	105	100	108
" 1045-30	104.5 "	105	110	102	110	105	113
" 1095-30	109.5 "	110	115	107	115	110	118
" 1145-30	114.5 "	115	120	112	120	115	123
" 1195-30	119.5 "	120	125	117	125	120	128
" 1245-30	124.5 ±0.60	125	130	122	130	125	133
" 1295-30	129.5 "	130	135	127	135	130	138
" 1345-30	134.5 "	135	140	132	140	135	143
" 1395-30	139.5 "	140	145	137	145	140	148
" 1445-30	144.5 "	145	150	142	150	145	153
" 1495-30	149.5 "	150	155	147	155	150	158
" 1545-30	154.5 "	155	160	152	160	155	163
" 1595-30	159.5 "	160	165	157	165	160	168
" 1645-30	164.5 "	165	170	162	170	165	173
" 1695-30	169.5 "	170	175	167	175	170	178
" 1745-30	174.5 "	175	180	172	180	175	183
" 1795-30	179.5 "	180	185	177	185	180	188
" 1845-30	184.5 ±0.80	185	190	182	190	185	193
" 1895-30	189.5 "	190	195	187	195	190	198
" 1945-30	194.5 "	195	200	192	200	195	203
" 1995-30	199.5 "	200	205	197	205	200	208
" 2095-30	209.5 "	210	215	207	215	210	218
" 2195-30	219.5 "	220	225	217	225	220	228
" 2295-30	229.5 "	230	235	227	235	230	238
" 2395-30	239.5 "	240	245	237	245	240	248
" 2445-30	244.5 "	245	250	242	250	245	253
" 2495-30	249.5 "	250	255	247	255	250	258

5.7 ±0.12mm Diameter Section A							
72-0443-57*	44.3 ±0.30	45	55	41	55	45	59
" 0453-57*	45.3 "	46	56	42	56	46	60
" 0493-57*	49.3 "	50	60	46	60	50	64
" 0523-57*	52.3 ±0.40	53	63	49	63	53	67
" 0543-57*	54.3 "	55	65	51	65	55	69
" 0553-57*	55.3 "	56	66	52	66	56	70
" 0593-57*	59.3 "	60	70	56	70	60	74
" 0623-57*	62.3 "	63	73	59	73	63	77
" 0643-57*	64.3 "	65	75	61	75	65	79
" 0693-57*	69.3 "	70	80	66	80	70	84

James Walker Number	Diameters			Flange Groove Diameters			
	Inside Dia. B	C, T	Cyl. D	Internal Pressure V max W (H11)		External Pressure V (h11) W min	
5.7 ±0.12mm Diameter Section A							
72-0743-57*	74.3 "	75	85	71	85	75	89
" 0793-57*	79.3 "	80	90	76	90	80	94
" 0843-57*	84.3 ±0.50	85	95	81	95	85	99
" 0893-57*	89.3 "	90	100	86	100	90	104
" 0943-57*	94.3 "	95	105	91	105	95	109
" 0993-57*	99.3 "	100	110	96	110	100	114
" 1043-57*	104.3 "	105	115	101	115	105	119
" 1093-57*	109.3 "	110	120	106	120	110	124
" 1143-57*	114.3 "	115	125	111	125	115	129
" 1193-57*	119.3 "	120	130	116	130	120	134
" 1243-57*	124.3 ±0.60	125	135	121	135	125	139
" 1293-57*	129.3 "	130	140	126	140	130	144
" 1343-57*	134.3 "	135	145	131	145	135	149
" 1393-57*	139.3 "	140	150	136	150	140	154
" 1443-57*	144.3 "	145	155	141	155	145	159
" 1493-57	149.3 "	150	160	146	160	150	164
" 1543-57	154.3 "	155	165	151	165	155	169
" 1593-57	159.3 "	160	170	156	170	160	174
" 1643-57	164.3 "	165	175	161	175	165	179
" 1693-57	169.3 "	170	180	166	180	170	184
" 1743-57	174.3 "	175	185	171	185	175	189
" 1793-57	179.3 ±0.80	180	190	176	190	180	194
" 1843-57	184.3 "	185	195	181	195	185	199
" 1893-57	189.3 "	190	200	186	199	190	204
" 1943-57	194.3 "	195	205	190	204	195	209
" 1993-57	199.3 "	200	210	195	209	200	214
" 2093-57	209.3 "	210	220	205	219	210	224
" 2193-57	219.3 "	220	230	215	229	220	234
" 2293-57	229.3 "	230	240	225	239	230	244
" 2393-57	239.3 "	240	250	235	249	240	254
" 2493-57	249.3 "	250	260	245	259	250	264
" 2593-57	259.3 ±1.00	260	270	255	269	260	274
" 2693-57	269.3 "	270	280	265	279	270	285
" 2793-57	279.3 "	280	290	275	289	280	295
" 2893-57	289.3 "	290	300	285	299	290	305
" 2993-57	299.3 "	300	310	295	309	300	315
" 3093-57	309.3 ±1.50	310	320	305	319	310	325
" 3193-57	319.3 "	320	330	315	329	320	335
" 3293-57	329.3 "	330	340	325	339	330	345
" 3393-57	339.3 "	340	350	335	349	340	355
" 3493-57	349.3 "	350	360	345	359	350	365
" 3793-57	379.3 "	380	390	375	389	380	395
" 3893-57	389.3 "	390	400	385	399	390	405
" 3993-57	399.3 "	400	410	395	409	400	415
" 4193-57	419.3 ±2.00	420	430	415	429	420	436
" 4393-57	439.3 "	440	450	435	449	440	456
" 4593-57	459.3 "	460	470	455	469	460	476
" 4793-57	479.3 "	480	490	475	489	480	496
" 4893-57	489.3 "	490	500	485	499	490	506
" 4993-57	499.3 "	500	510	495	509	500	516

8.4 ±0.15mm Diameter Section A							
72-1441-84*	144.1 ±0.60	145	160	140	160	145	165
" 1491-84*	149.1 "	150	165	145	165	150	170
" 1541-84*	154.1 "	155	170	150	170	155	175
" 1591-84*	159.1 "	160	175	155	175	160	180
" 1641-84*	164.1 "	165	180	160	180	165	185
" 1691-84*	169.1 "	170	185	165	185	170	190
" 1741-84*	174.1 "	175	190	170	190	175	195
" 1791-84*	179.1 "	180	195	175	195	180	200
" 1841-84*	184.1 ±0.80	185	200	180	200	185	205
" 1891-84*	189.1 "	190	205	185	205	190	210
" 1941-84*	194.1 "	195	210	190	210	195	215
" 1991-84*	199.1 "	200	215	195	215	200	220
" 2041-84*	204.1 "	205	220	200	220	205	225
" 2091-84*	209.1 "	210	225	205	225	210	230
" 2191-84*	219.1 "	220	235	215	235	220	240
" 2291-84*	229.1 "	230	245	225	245	230	250
" 2341-84*	234.1 "	235	250	230	250	235	255
" 2391-84*	239.1 "	240	255	235	255	240	260
" 2491-84*	249.1 "	250	265	245	265	250	270

Chart 17000: inch sizes

Refer to page 29 for List of Symbols

INCH SIZES			
James Walker Number	Dias. B, C, P, T	Tol. on B	Dias. D, Q
0.063 ±0.003" Diameter Section A			
17001	0.125	±0.004	0.250
17002	0.156	"	0.281
17003	0.188	±0.005	0.313
17004	0.219	"	0.344
17005	0.250	"	0.375
17006	0.281	"	0.406
17007	0.313	"	0.438
17008	0.344	"	0.469
17009	0.375	"	0.500
17010	0.406	±0.006	0.531
17011	0.438	"	0.563
17012	0.469	"	0.594
17013	0.500	"	0.625
0.094 ±0.003" Diameter Section A			
17014*	0.469	±0.006	0.656
17015*	0.500	"	0.688
17016*	0.531	"	0.719
17017*	0.563	"	0.750
17018*	0.594	"	0.781
17019*	0.625	"	0.813
17020*	0.656	"	0.844
17021*	0.688	"	0.875
17022*	0.719	"	0.906
17023*	0.750	"	0.938
17024*	0.781	"	0.969
17025*	0.813	±0.008	1.000
17026*	0.875	"	1.063
17027*	0.938	"	1.125
17028*	1.000	"	1.188

INCH SIZES			
James Walker Number	Dias. B, C, P, T	Tol. on B	Dias. D, Q
0.125 ±0.004" Diameter Section A			
17029*	1.000	±0.008	1.250
17030*	1.063	"	1.313
17031*	1.125	"	1.375
17032*	1.188	"	1.438
17033*	1.250	"	1.500
17034*	1.313	"	1.563
17035*	1.375	"	1.625
17036*	1.438	"	1.688
17037*	1.500	±0.011	1.750
17038*	1.563	"	1.813
17039*	1.625	"	1.875
17040*	1.688	"	1.938
17041*	1.750	"	2.000
17042*	1.813	"	2.063
17043*	1.875	"	2.125
17044*	1.938	"	2.188
17045*	2.000	"	2.250
17046*	2.125	"	2.375
17047*	2.250	"	2.500
17048*	2.375	"	2.625
17049*	2.500	"	2.750
17050*	2.625	"	2.875
17051*	2.750	"	3.000
17052*	2.875	±0.016	3.125
17053*	3.000	"	3.250

INCH SIZES			
James Walker Number	Dias. B, C, P, T	Tol. on B	Dias. D, Q
0.188 ±0.005" Diameter Section A			
17054*	3.000	±0.016	3.375
17055*	3.125	"	3.500
17056*	3.250	"	3.625
17057*	3.375	"	3.750
17058*	3.500	"	3.875
17059*	3.625	"	4.000
17060*	3.750	"	4.125
17061*	3.875	"	4.250
17062*	4.000	"	4.375
17063*	4.125	"	4.500
17064*	4.250	"	4.625
17065*	4.375	"	4.750
17066*	4.500	"	4.875
17067*	4.625	"	5.000
17068*	4.750	"	5.125
17069*	4.875	"	5.250
17070*	5.000	"	5.375
17071*	5.125	±0.021	5.500
17072*	5.250	"	5.625
17073*	5.375	"	5.750
17074*	5.500	"	5.875
17075*	5.625	"	6.000
17076*	5.750	"	6.125
17077*	5.875	"	6.250
17078*	6.000	"	6.375

INCH SIZES			
James Walker Number	Dias. B, C, P, T	Tol. on B	Dias. D, Q
0.250 ±0.006" Diameter Section A			
17079*	6.000	±0.021	6.500
17080*	6.250	"	6.750
17081*	6.500	"	7.000
17082*	6.750	"	7.250
17083*	7.000	"	7.500
17084*	7.250	±0.030	7.750
17085*	7.500	"	8.000
17086*	7.750	"	8.250
17087*	8.000	"	8.500
17088	8.250	"	8.750
17089	8.500	"	9.000
17090	8.750	"	9.250
17091	9.000	"	9.500
17092	9.250	"	9.750
17093	9.500	"	10.000
17094	9.750	"	10.250
17095	10.000	"	10.500
17096	10.250	±0.040	10.750
17097	10.500	"	11.000
17098	10.750	"	11.250
17099	11.000	"	11.500
17100	11.250	"	11.750
17101	11.500	"	12.000
17102	11.750	"	12.250
17103	12.000	"	12.500
17104	12.500	"	13.000
17105	13.000	"	13.500
17106	13.500	"	14.000
17107	14.000	"	14.500
17108	14.500	"	15.000
17109	15.000	"	15.500
17110	15.500	"	16.000
17111	16.000	±0.055	16.500
17112	16.500	"	17.000
17113	17.000	"	17.500
17114	17.500	"	18.000
17115	18.000	"	18.500
17116	18.500	"	19.000
17117	19.000	"	19.500
17118	19.500	"	20.000
17119	20.000	±0.075	20.500
17120	20.500	"	21.000
17121	21.000	"	21.500
17122	21.500	"	22.000
17123	22.000	"	22.500
17124	22.500	"	23.000
17125	23.000	"	23.500
17126	23.500	"	24.000
17127	24.000	"	24.500

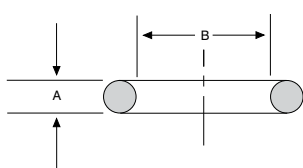

'O' ring diameter section A and inside diameter B.

James Walker originally developed this **Chart 17000** inch range of 'O' rings for the Royal Navy. However, its popularity has led to its use in many industries, and this is reflected in it being stocked in our four most popular materials.

If the inch size you want is not available in **Chart 17000**, please check the inch columns in **Chart 50** or **Aerospace sizes to BS ISO 3601-1**.

Housing details can be referred to on pages 29-31.

*** Static/dynamic applications**

An asterisk symbol (*) denotes that the ring is suitable for both dynamic and static applications. Other sizes are not recommended for dynamic duties.



Non-standard sizes

Methods of production

Using one of the following techniques, we are able to produce any size of 'O' ring you require.

Precision moulded

For this, our main method of production, we hold a growing inventory of over 8,000 mould tools. We also have one of the largest presses of its type in Europe for moulding endless rings up to 2.2m (87 inch) diameter.

This press is used to produce high-integrity seals, including those for nuclear fuel transportation flasks. The nature of such an application demands stringent quality procedures. James Walker design technologists worked closely with our customer with this successful project.

Extruded & mould joined

This approach is particularly economical when a high degree of precision is unnecessary: for example, large diameter non-standard 'O' rings for static duties.

The ring is made from extruded cord by vulcanising the ends together in a mould tool. Rings must have a minimum section diameter of 3mm (0.12 inch) and a minimum ID of 200mm (7.9 inch). Maximum ID is unlimited.

NOTE: This method must not be confused with rings joined by contact adhesive. Generally, the use of such adhesives results in a less secure join, with operating temperature limits below that of the cord material.

Mould & mould-joined

This method is used when the non-standard 'O' ring must have a diameter section to very close tolerances and a mould-join is acceptable.

It is often applied to sizes above 2.2m diameter, when two or more smaller rings are manufactured, then cut and mould-joined.

Tolerances for moulded 'O' rings of non-standard sizes

These tables show the tolerances on diameter section A and inside diameter B. They meet the requirements for non-standard sizes in BS ISO 3601-1.

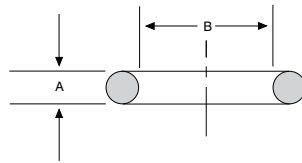

Tolerances on Diameter Section A

Nominal section mm / inch		Limits mm / inch
Above	Up to and including	
-	3.15 / 0.124	± 0.08 / 0.003
3.15 / 0.124	4.5 / 0.177	± 0.10 / 0.004
4.5 / 0.177	6 / 0.236	± 0.12 / 0.005
6 / 0.236	6.3 / 0.248	± 0.13 / 0.005
6.3 / 0.248	8.4 / 0.331	± 0.15 / 0.006
8.4 / 0.331	10 / 0.394	± 0.21 / 0.008
10 / 0.394	12.7 / 0.50	± 0.25 / 0.010

Tolerances on Inside Diameter B

Internal diameter mm / inch		Limits mm / inch
Above	Up to and including	
-	3 / 0.118	± 0.08 / 0.003
3 / 0.118	18 / 0.709	± 0.13 / 0.005
18 / 0.709	22 / 0.866	± 0.20 / 0.008
22 / 0.866	30 / 1.181	± 0.23 / 0.009
30 / 1.181	50 / 1.969	± 0.28 / 0.011
50 / 1.969	80 / 3.150	± 0.40 / 0.016
80 / 3.150	120 / 4.724	± 0.50 / 0.020
120 / 4.724	180 / 7.087	± 0.60 / 0.024
180 / 7.087	250 / 9.843	± 0.80 / 0.031
250 / 9.843	300 / 11.81	± 1.00 / 0.039
300 / 11.81	400 / 15.75	± 1.50 / 0.059
400 / 15.75	500 / 19.69	± 1.90 / 0.075
500 / 19.69	720 / 28.35	± 2.40 / 0.094
720 / 28.35	860 / 33.86	± 3.56 / 0.140
860 / 33.86	1010 / 39.76	± 4.06 / 0.160
1010 / 39.76	1165 / 45.87	± 4.57 / 0.180
1165 / 45.87	1325 / 52.17	± 5.08 / 0.200
1325 / 52.17	1700 / 66.95	± 6.00 / 0.236
1700 / 66.95	-	± 7.00 / 0.276

Note: For tolerances for extruded and mould-joined, and mould and mould-joined non-standard size 'O' rings, please consult our Technical Support Team.

Complementary products

Coloured materials

Where stocks of our precision-moulded 'O' rings are held by users in different black-coloured materials, it can be possible to select the wrong item for a specific application and cause an equipment malfunction.

To help overcome this, we offer the following non-black compounds:

Fluorocarbon (FKM) — green
Silicone (VMQ) — white or red.

Note that physical properties may vary from those of our standard materials. Please consult our Technical Support Team for specific recommendations.



'O' ring cord

We supply a large selection of 'O' ring cord in metric and inch cross sections in:

FR10/80 fluorocarbon (80 IRHD)
PB70 nitrile (70 IRHD)
EP21/E/80 ethylene-propylene (80 IRHD)
GN/W/70 chloroprene/neoprene (70 IRHD).

Standard cross sections:

1.6mm	1/16 inch
1.78mm	0.070 inch
2.0mm	0.079 inch
2.4mm	3/32 inch
2.62mm	0.103 inch
3.0mm	0.118 inch
3.18mm	1/8 inch
3.53mm	0.139 inch
4.0mm	5/32 inch
4.5mm	0.177 inch
4.76mm	3/16 inch
5.0mm	0.197 inch
5.33mm	0.210 inch
5.7mm	0.224 inch
6.0mm	0.236 inch
6.35mm	1/4 inch
6.99mm	0.275 inch
8.0mm	5/16 inch
8.73mm	11/32 inch
9.5mm	3/8 inch
10mm	0.394 inch
10.32mm	13/32 inch
11.1mm	7/16 inch
11.91mm	15/32 inch
12.7mm	1/2 inch



How supplied

'O' ring cord is available by the metre to any length.

Most of the elastomers and cord sizes are supplied from stock or on short lead times. Other sizes and elastomers are available on request.

All our 'O' ring cords are manufactured to BS 3734-1 and ISO 3302-1, with Class E2 as standard.

Commercial quality 'O' rings

To complement our premium products, we supply general purpose 'commercial quality' 'O' rings for less critical duties.

These are available with:

- Competitive prices.
- Full traceability — on request.
- Wide range of materials and sizes.
- Any quantity from tens to millions.

Materials: we offer a comprehensive range including

Ethylene-propylene (EPM/EPDM)
Chloroprene/neoprene (CR)
Nitrile (NBR)
Polyurethane (AU/EU)
Silicone (VMQ)
Fluoroelastomer (FKM).

How supplied

Commercial 'O' rings are supplied to the following James Walker Chart sizes:

- JW46: covering BS 1806 & SAE AS 568.
- JW47: other metric sizes.
- JW48: metric sizes to BS4518.
- JW49: Japanese industry sizes.

Non-standard sizes are also available in commercial materials to suit specific requirements. Please contact our Technical Support Team to determine suitability.

Complementary products

'O' ring kits

These three boxed kits offer excellent value for money in terms of quantity, quality and convenience.

They are recommended for maintenance engineers and equipment refurbishers who need a good selection of nitrile (NBR) 'O' rings constantly available to suit general industrial applications.

The boxes are designed to withstand industrial maintenance activities, and have partitions to hold all items separately and securely. From the kit layouts, users can readily see when they are running low on a particular size of ring or cord.

'O' ring sealing kit — metric sizes

(JW order code ZL000186)

Box containing nitrile (NBR) elastomer rings of 70 IRHD:

- 404 rings in total.
- In 30 sizes ranging from 3mm ID x 2mm section, up to 45mm ID x 4mm section.

'O' ring sealing kit — inch sizes

(JW order code ZL000097)

Box containing nitrile (NBR) elastomer rings of 70 IRHD:

- 382 'O' rings in total.
- In 30 sizes ranging from 1/8 inch ID x 1/16 inch section, up to 1 3/4 inch ID x 3/16 inch section.

Service kit — 'O' ring cord

(JW order code ZL000275)

Box containing tools and nitrile (NBR) elastomer 'O' ring cord of 70 IRHD.

- 14 off 2m lengths: 1.78mm (0.070 inch) diameter, 2.0mm, 2.4mm, 2.62mm (0.103 inch), 3.0mm, 3.5mm, (0.138 inch), 4.0mm, 4.5mm, 5.0mm, 5.33mm (0.210 inch), 5.7mm, 6.0mm, 6.99mm (0.275 inch), 8.0mm.
- Tape measure, retractable blade knife, splicing aid, adhesive for forming rings, and full instructions.

Note: Rubber hardness values (IRHD) quoted are nominal.



Special packaging & kits

Special packaging and bagging can be provided for all our 'O' rings. These range from individual bagged rings, to complete sealing kits containing a variety of sizes and materials suitable for refurbishing a specific item of equipment.

Bags and kits can be custom-branded and over printed with dedicated part numbers to simplify ordering, stocking and issuing routines.



In addition, your company name and logo can be printed on the bag or label to provide a custom packaged kit with your own references. This will save additional repackaging if you are re-selling.

'O' ring lubricants

We recommend the following lubricants be applied lightly to 'O' rings before assembly (*but please note the important Exceptions*):

- **James Walker Molyon Grease** containing MoS₂, for operating temperatures from -20°C to +150°C.
- **James Walker Silicone Grease**, for operating temperatures from -50°C to +200°C.
- **James Walker Copper Anti-Seize Compound or Nickel Anti-Seize Compound**, for operating temperatures above +200°C.

Exceptions

DO NOT use mineral-based oil or grease, such as our **Molyon** and **Anti-Seize Compounds** on seals made from natural rubber (NR), butyl (IIR) or ethylene-propylene (EPM/EPDM). Likewise, **DO NOT** use **Silicone Grease** or oil on seals made from silicone (VMQ) compounds.

General design notes

How 'O' rings work

Rubber has a very high bulk modulus and is therefore virtually incompressible. This means that an 'O' ring must be deformed on the diameter section to give it an initial sealing force within a housing (*Figure 1*).

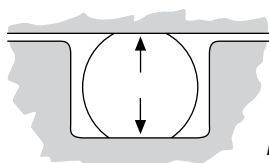

Figure 1

When system pressure is applied, the 'O' ring deforms further (*Figure 2*). But because of the initial squeeze, the sealing force always exceeds the force exerted on the 'O' ring by the system pressure.

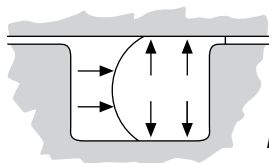

Figure 2

At higher pressures, back-up rings may be required to prevent 'O' ring extrusion (see *page 12*). Leakage problems often arise due to lack of initial squeeze, or the 'O' ring diameter section being too large for its housing.

Reciprocating applications

'O' rings marked with an asterisk (*) on our charts can be used for both static and light/medium reciprocating duties. Other sizes are not recommended for these dynamic applications.

Rotary applications

'O' rings may be used for rotating applications where peripheral speeds are low. Please contact our Technical Support Team for recommendations.

**Non-standard housing diameters**

Individual rings can be stretched or squeezed very slightly to fit housing diameters that do not match the dimensions specified on our 'O' ring size charts.

The amount of allowable deformation varies according to the application, as follows:

- **Groove in cylinder application:**
A maximum of 3 per cent squeeze is acceptable on an 'O' ring outside diameter to fit a shaft diameter C that is not covered by JW chart sizes. (See *Figs 5 & 6, page 29.*)
- **Groove in piston application:**
A maximum of 4 per cent stretch is acceptable on an 'O' ring inside diameter to fit a cylinder diameter D that is not covered by JW chart sizes. (See *Figs 7 & 8, page 29.*)
- **Flange and triangular groove applications:** A maximum of 2 per cent stretch is acceptable on an 'O' ring inside diameter when the seal is used on an external pressure flange, or housed in a triangular groove. (See *Fig 9, page 29.*)
Likewise, a maximum of 1 per cent squeeze is acceptable on an 'O' ring outside diameter when the seal is used on an internal pressure flange. (See *Fig 10, page 29.*)

Cylinder and piston housing tolerances

It is important that tolerances on housing diameters for cylinders and pistons meet the requirements of the formulae given on *page 29* (ie, dimensions C and D in *Figures 5-8*).

Surface finish of metal parts

For maximum seal life the surface finish of metal parts in contact with an 'O' ring should not exceed:

- 0.8 μ m (32 μ in) CLA or Ra for static parts.
- 0.4 μ m (16 μ in) CLA or Ra for moving parts.

A finish finer than 0.15 μ m (6 μ in) should be avoided in dynamic applications as a lubricating film may not be retained. For details of these finishes, please refer to BS 1134: *Assessment of surface texture.*

Diametral clearance G

Under no circumstances should the maximum total diametral clearance (G max) indicated on our housing tables (*pages 30-31*) be exceeded. This is to ensure that, if complete shaft offset occurs, the maximum extrusion gap at any point on the 'O' ring does not exceed G.

General design notes



Pressure restrictions

'O' rings are generally suitable for pressures up to 10MPa (1450psi). Where higher pressures are involved, we recommend the use of back-up rings as described on page 12.

For stuffing box applications we recommend piston-type grooves, although triangular grooves are generally acceptable for pressures below 10MPa (1450psi): see Figures 3 & 4.

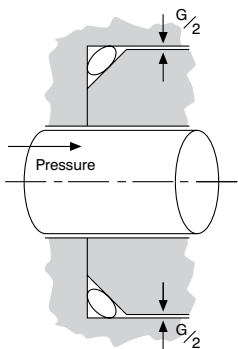

Figure 3

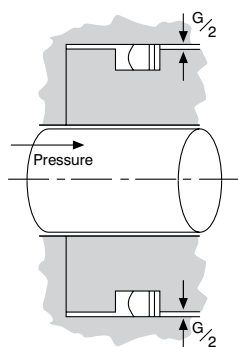

Figure 4

For flange applications, 'O' rings will normally be suitable for sealing pressures above 10MPa (1450psi) where metal-to-metal contact prevents extrusion.

Complex dynamic, high vacuum or high temperature duties

Groove dimensions quoted allow for expansion, swell and retention of interference over the longest possible seal life. However, these dimensions may not suit complex dynamic applications, static duties with high vacuum, or high temperature applications. Please contact our Technical Support Team for recommendations.

Seven useful hints

- Select the largest diameter section 'O' ring to fit the nominal groove size. This will absorb adverse tolerances in metal parts and aid durability, particularly in high temperature applications.
- Rapid gas decompression (RGD) environments are the exception — see page 11. To minimise gas permeation, the smallest possible diameter section, that does not compromise mechanical sealing efficiency, should be used. Please contact our Technical Support Team for recommendations.
- Consider how the 'O' ring will pass over other parts during assembly. Provide the lead-ins as recommended on page 29 (Figures 5 & 7), remove all burrs, and use thin fitting sleeves where appropriate.
- Smear seals lightly with a suitable lubricant before assembly (see page 26 for recommendations).
- On reciprocating applications always check whether a standard 'O' ring is suitable. Those suitable are indicated with an asterisk (*) in our product charts.
- With a cylinder or piston groove, where the 'O' ring inside diameter is less than three times the diameter section, a two-part recess — with component split at the 'O' ring housing — may be required to facilitate assembly. This is because it is impractical to stretch or squeeze the seal into position without causing damage.
- Always store 'O' rings under conditions that meet the requirements of BS ISO 2230: *Rubber products — Guidelines for storage*, or BS F 68: *Controlled storage of vulcanised rubbers for use in aerospace applications*.

Housing design

'O' ring design notes – Housings for general service

Housing arrangements

Figure 5: Groove in cylinder

Max. lead in dia. = Min. groove dia. - 2A max. - G

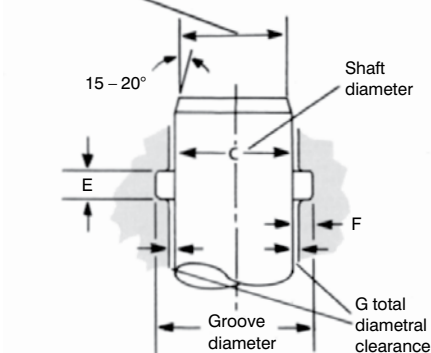

Max. groove dia. = C min. + 2F max.
Min. groove dia. = C max. + 2F min.

Figure 6: Plug groove, terminology as figures 5 and 14

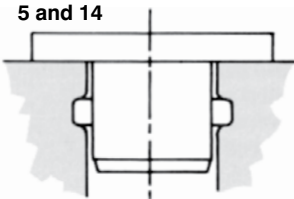
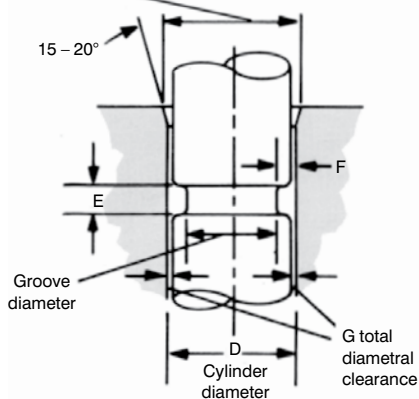

Figure 7: Groove in piston

Min. lead in dia. = Max. groove dia. + 2A max. + G



Max. groove dia. = D min. - 2F min.
Min. groove dia. = D max. - 2F max.

Figure 8: Plug groove, terminology as figures 7 and 14

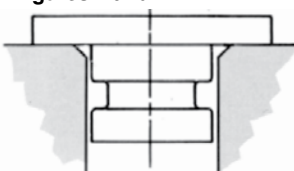

Figure 9: Groove in flange, external pressure

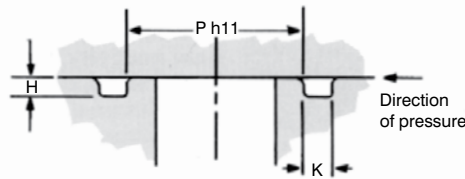

Figure 10: Groove in flange, internal pressure

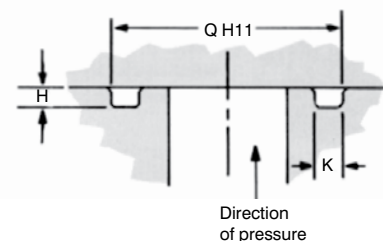

Figure 11: Groove in flange, Chart 72

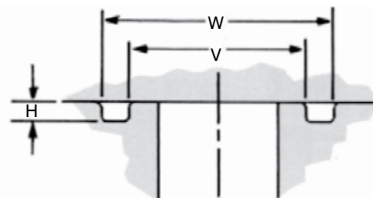

Figure 12: Triangular groove

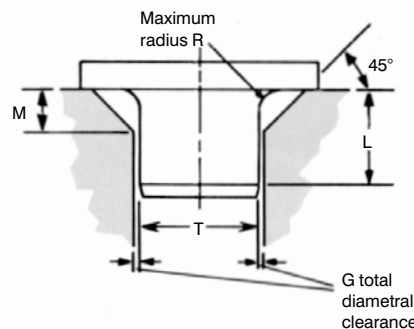

Figure 13: Dovetail groove

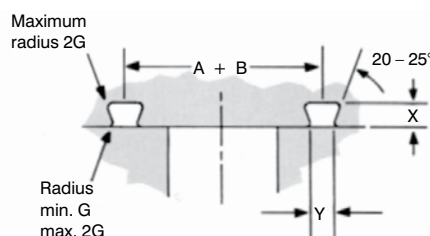
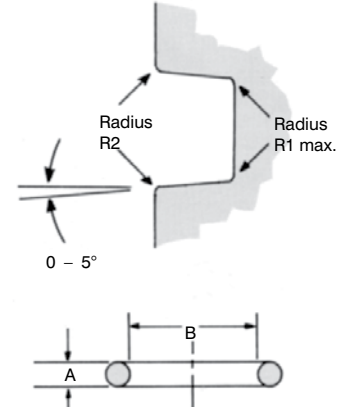

Figure 14: Groove radii and taper for figures 5-11



List of symbols

The following symbols are used throughout this guide:

- A 'O' ring diameter section
- B 'O' ring inside diameter
- C Shaft diameter
- D Cylinder diameter
- E Groove width
- F Groove radial depth
- G Maximum diametral clearance
- H Flange groove depth
- h11 BS EN ISO 286-2 tolerance (shafts)
- H11 BS EN ISO 286-2 tolerance (holes)
- K Minimum flange groove width
- L Minimum spigot length
- M Triangular groove chamfer
- P Flange groove inside diameter
- Q Flange groove outside diameter
- R Triangular groove radius
- R1 Corner radius (maximum) at groove base
- R2 Corner radius at groove entrance
- T Triangular groove inside diameter
- V BS 4518 flange groove inside diameter
- W BS 4518 flange groove outside diameter
- X Dovetail groove depth
- Y Dovetail groove width

Housing design

Figures in **red** relate to **BS 1806**, **BS 4518** and **BS 5106**. Please contact our Technical Support Team for housings to **BS ISO 3601-2** Fluid power systems — 'O' rings — Part 2: Housing dimensions for general applications.

Metric Groove Dimensions				All dimensions in millimetres.										
Diameter Section	Groove Width E			Radial Depth F	Diametrical Clearance G max	Flange Groove		Triangular Groove			Groove Radii		Dovetail Groove	
	A	'O'ring only	+1 back-up			+2 back-up	Depth H	K min	L min	Chamfer M	R max	R1 max	R2	Depth X
1.0/1.02	1.5/1.6	#	#	0.81/0.86	0.11	0.7/0.8	1.8	#	#	#	0.2	0.11/0.22	#	#
1.27	1.8/1.9	#	#	1.06/1.11	0.11	0.9/1.0	2.1	#	#	#	0.3	0.11/0.22	#	#
1.5/1.52	2.1/2.2	#	#	1.26/1.32	0.12	1.1/1.2	2.4	3.0	2.08/2.20	0.8	0.3	0.12/0.24	#	#
1.6	2.3/2.5	3.7/3.9	5.0/5.2	1.18/1.25	0.12	1.2/1.3	2.4	4.0	2.20/2.32	0.8	0.2	0.20/0.40	1.37/1.43	1.34/1.40
1.78	2.3/2.5	3.8/3.9	5.3/5.4	1.52/1.57	0.13	1.3/1.5	2.4	4.8	2.41/2.54	0.8	0.8	0.13/0.25	1.50/1.56	1.50/1.56
2.0	2.6/2.7	4.1/4.2	5.6/5.7	1.72/1.79	0.12	1.6/1.7	2.8	4.0	2.71/2.83	1.0	0.4	0.12/0.24	1.65/1.72	1.70/1.77
2.4	3.2/3.4	4.6/4.8	6.0/6.2	1.97/2.09	0.14	1.7/1.8	3.7	5.0	3.30/3.42	1.3	0.5	0.20/0.40	1.96/2.04	2.05/2.13
2.5	3.2/3.3	4.7/4.8	6.2/6.3	2.17/2.25	0.13	2.0/2.1	3.4	5.0	3.46/3.59	1.3	0.5	0.13/0.26	2.05/2.13	2.15/2.23
2.62	3.5/3.7	5.0/5.1	6.5/6.6	2.31/2.39	0.13	2.1/2.3	3.6	6.4	3.68/3.81	1.0	0.8	0.13/0.25	2.16/2.24	2.26/2.34
3.0	4.0/4.2	5.4/5.6	6.8/7.0	2.50/2.65	0.15	2.2/2.3	4.5	6.0	4.20/4.32†	2.0	1.0	0.20/0.40	2.46/2.55†	2.58/2.67
3.5/3.53	4.7/4.9	6.2/6.4	7.7/7.9	3.10/3.18	0.15	2.8/3.0	4.8	7.9	4.95/5.08†	1.5	0.8	0.13/0.25	2.89/2.99†	3.03/3.13
4.0	5.1/5.3	6.6/6.8	8.1/8.3	3.52/3.62	0.15	3.2/3.4	5.5	8.0	5.75/5.90	2.0	0.8	0.15/0.30	3.32/3.42†	3.48/3.58
4.1	5.5/5.7	7.1/7.3	8.7/8.9	3.50/3.67	0.16	3.1/3.2	6.0	8.0	5.60/5.72†	2.5	1.0	0.20/0.40	3.39/3.50†	3.59/3.70
4.5	5.8/6.0	7.6/7.8	9.4/9.6	3.96/4.07	0.16	3.7/3.9	6.0	9.0	6.45/6.61	2.3	0.9	0.16/0.32	3.74/3.85†	3.92/4.03
5.0	6.4/6.6	8.2/8.4	10.0/10.2	4.42/4.54	0.16	4.1/4.3	6.7	10.0	7.18/7.34	2.5	1.0	0.16/0.32	4.23/4.35	4.37/4.49
5.33	7.0/7.2	8.8/9.0	10.6/10.8	4.67/4.78	0.18	4.3/4.5	7.1	11.1	7.49/7.62	2.3	0.8	0.13/0.25	4.54/4.67	4.64/4.77
5.7	7.5/7.7	9.3/9.5	11.1/11.3	4.95/5.18	0.18	4.4/4.5	8.1	10.0	7.80/7.92†	3.0	1.0	0.20/0.40	4.80/4.94	4.98/5.12
6.0	7.8/8.0	9.6/9.8	11.4/11.6	5.31/5.45	0.18	5.0/5.2	7.9	12.0	8.64/8.82	3.0	1.2	0.18/0.36	5.02/5.16	5.25/5.39
6.99/7.0	9.4/9.6	12.0/12.2	14.6/14.8	6.22/6.35	0.20	5.9/6.1	9.4	14.3	10.03/10.16	2.5	0.8	0.13/0.25	5.85/6.01	6.12/6.28
8.0	10.7/10.9	13.3/13.5	15.9/16.1	7.09/7.27	0.20	6.7/6.9	10.6	16.0	11.61/11.81	4.0	1.6	0.20/0.40	6.70/6.88	7.01/7.19
8.4	11.0/11.2	13.6/13.8	16.2/16.4	7.50/7.75	0.20	6.6/6.7	12.0	14.0	11.50/11.62†	4.0	1.0	0.20/0.40	7.02/7.21	7.34/7.53
9.0	12.3/12.5	15.6/15.8	18.9/19.1	7.97/8.17	0.21	7.5/7.7	12.1	18.0	13.08/13.29	4.5	1.8	0.21/0.42	7.54/7.74	7.89/8.09
9.5/9.53	13.1/13.3	16.4/16.6	19.7/19.9	8.43/8.64	0.22	8.0/8.2	12.7	19.0	13.83/14.05	4.8	1.9	0.22/0.44	7.97/8.18	8.34/8.55
10.0	13.8/14.0	17.1/17.3	20.4/20.6	8.89/9.10	0.23	8.4/8.6	13.3	20.0	14.58/14.81	5.0	2.0	0.23/0.46	8.41/8.62	8.80/9.01
12.5/12.7	18.5/18.8	21.8/22.1	25.1/25.4	11.13/11.39	0.26	10.5/10.8	17.4	25.0	18.30/18.56	6.3	2.5	0.26/0.52	10.52/10.78	11.01/11.27

Inch Groove Dimensions				All dimensions in inches.										
Diameter Section	Groove Width E			Radial Depth F	Diametrical Clearance G max	Flange Groove		Triangular Groove			Groove Radii		Dovetail Groove	
	A	'O'ring only	+1 back-up			+2 back-up	Depth H	K min	L min	Chamfer M	R max	R1 max	R2	Depth X
0.040	.059/.063	#	#	.032/.034	.004	.028/.032	.068	#	#	#	.008	.004/.008	#	#
0.050	.069/.073	#	#	.042/.044	.004	.037/.041	.078	#	#	#	.010	.004/.008	#	#
0.060	.080/.085	#	#	.051/.053	.005	.045/.050	.091	.120	.082/.087	.030	.012	.005/.010	#	#
0.063	.084/.089	.142/.147	.200/.205	.053/.055	.005	.047/.052	.094	.125	.086/.091	.031	.013	.005/.010	.054/.056	.053/.055
0.070	.089/.099	.147/.152	.205/.210	.060/.062	.005	.051/.061	.095	.188	.095/.100	.030	.030	.005/.010	.059/.062	.059/.062
0.094	.121/.126	.179/.184	.237/.242	.081/.084	.005	.075/.080	.129	.188	.129/.134	.047	.019	.005/.010	.077/.080	.080/.083
0.103	.136/.146	.194/.199	.252/.257	.091/.094	.005	.081/.091	.140	.250	.145/.150	.040	.030	.005/.010	.085/.088	.089/.092
0.125	.159/.164	.217/.222	.275/.280	.110/.114	.005	.102/.107	.168	.250	.183/.188	.063	.025	.005/.010	.103/.107†	.107/.111
0.139	.183/.193	.241/.247	.299/.305	.122/.125	.006	.110/.120	.190	.313	.195/.200†	.060	.030	.005/.010	.115/.119†	.120/.124
0.188	.240/.246	.312/.318	.384/.390	.166/.171	.006	.155/.161	.248	.375	.269/.275	.094	.038	.006/.012	.156/.161†	.163/.168
0.210	.276/.286	.348/.355	.420/.427	.184/.188	.007	.170/.180	.280	.438	.295/.300	.090	.030	.005/.010	.179/.184	.183/.188
0.250	.328/.335	.430/.437	.532/.539	.221/.227	.007	.207/.214	.333	.500	.360/.367	.125	.050	.007/.014	.208/.214	.218/.224
0.275	.370/.380	.472/.480	.574/.582	.245/.250	.008	.231/.241	.370	.563	.395/.400	.100	.030	.005/.010	.230/.236	.241/.247
0.375	.514/.523	.644/.653	.774/.783	.333/.341	.009	.314/.323	.501	.750	.545/.554	.188	.075	.009/.018	.315/.323	.329/.337
0.500	.718/.728	.848/.858	.978/.988	.446/.456	.010	.421/.431	.674	1.000	.733/.743	.250	.100	.010/.020	.421/.431	.441/.451

Key: [Chart 50](#) [Chart 72](#) [Chart 17000](#)

Diameter section A indicated is too small for this groove type.

† These dimensions can be used only with moulded 'O' rings. Use tables for *Triangular groove sizes* and *Dovetail groove sizes* on page 31 for 'O' rings manufactured by other methods.

Housing design

ISO 286-2 Limits and Fits

Extract (See Figures 9 - 11, page 29)

Nom.	Diameter up to and including	Tolerance	
		H11	h11
-	3	+0/+0.060	-0/-0.060
3	6	+0/+0.075	-0/-0.075
6	10	+0/+0.090	-0/-0.090
10	18	+0/+0.110	-0/-0.110
18	30	+0/+0.130	-0/-0.130
30	50	+0/+0.160	-0/-0.160
50	80	+0/+0.190	-0/-0.190
80	120	+0/+0.220	-0/-0.220
120	180	+0/+0.250	-0/-0.250
180	250	+0/+0.290	-0/-0.290

continued

Nom.	Diameter up to and including	Tolerance	
		H11	h11
250	315	+0/+0.320	-0/-0.320
315	400	+0/+0.360	-0/-0.360
400	500	+0/+0.400	-0/-0.400
500	630	+0/+0.440	-0/-0.440
630	800	+0/+0.500	-0/-0.500
800	1000	+0/+0.560	-0/-0.560
1000	1250	+0/+0.660	-0/-0.660
1250	1600	+0/+0.780	-0/-0.780
1600	2000	+0/+0.920	-0/-0.920
2000	2500	+0/+1.100	-0/-1.100
2500	3150	+0/+1.350	-0/-1.350

All dimensions in millimetres

For 'O' rings manufactured by extrusion

Triangular
Groove Sizes

Diameter Section A	Triangular Chamfer M
Metric (mm)	
3.0	4.48/4.63
3.5/3.53	5.10/5.25
4.1	6.00/6.16
5.7	8.18/8.36
8.4	12.18/12.38
Inch	
0.139	.201/.207

Dovetail
Groove Sizes

Diameter Section A	Dovetail Depth X
Metric (mm)	
3.0	¥
3.5/3.53	¥
4.0	3.48/3.58
4.1	3.59/3.70
4.5	3.88/3.99
Inch	
0.125	¥
0.139	¥
0.188	.159/.164

¥ 'O' rings not suitable for dovetail grooves.

Trademark acknowledgements

James Walker acknowledges the following trademarks as mentioned in this guide. All other names bearing the ® symbol are registered trademarks of James Walker.

Aflas®	Asahi Glass
Dyneon™	3M Dyneon
Kalrez®	DuPont Performance Elastomers
PEEK™	Victrix plc
Tecnoflon®	Solvay Solexis
Viton®	DuPont Performance Elastomers

General information

Health warning: If PTFE or fluoroelastomer (eg, FKM, FFKM, FEPM) products are heated to elevated temperatures, fumes will be produced which may give unpleasant effects, if inhaled. Whilst some fumes are emitted below 250°C from fluoroelastomers or below 300°C from PTFE, the effect at these temperatures is negligible. Care should be taken to avoid contaminating tobacco with particles of PTFE or fluoroelastomer, or with PTFE dispersion, which may remain on hands or clothing. Material Safety Data Sheets (MSDS) are available on request.

Information in this publication and otherwise supplied to users is based on our general experience and is given in good faith, but because of factors which are outside our knowledge and control and affect the use of products, no warranty is given or is to be implied with respect to such information. Unless governed by type approval or contract, specifications are subject to change without notice. Statements of operating limits quoted in this publication are not an indication that these values can be applied simultaneously.

To ensure you are working with the very latest product specifications, please consult the relevant section of the James Walker website: www.jameswalker.biz.

James Walker companies worldwide

James Walker & Co

Tel: +44 (0)1270 536000
Fax: +44 (0)1270 536100
Email: csc@jameswalker.biz

James Walker Australia

Tel: +61 (0)2 9721 9500
Fax: +61 (0)2 9721 9580
Email: sales.au@jameswalker.biz

James Walker Benelux

(Belgium)
Tel: +32 3 820 7900
Fax: +32 3 828 5484
Email: sales.be@jameswalker.biz
(Netherlands)
Tel: +31 (0)186 633111
Fax: +31 (0)186 633110
Email: sales.nl@jameswalker.biz

James Walker Brasil

Tel: +55 21 2220 2152
Fax: +55 21 253 11704
Email: sales.br@jameswalker.biz

James Walker China

Tel: +86 21 6876 9351
Fax: +86 21 6876 9352
Email: sales.cn@jameswalker.biz

James Walker Deutschland

Tel: +49 (0)40 386 0810
Fax: +49 (0)40 389 3230
Email: sales.de@jameswalker.biz

James Walker France

Tel: +33 (0)437 497 480
Fax: +33 (0)437 497 483
Email: sales.fr@jameswalker.biz

James Walker Iberica

Tel: +34 94 447 0099
Fax: +34 94 447 1077
Email: sales.es@jameswalker.biz

James Walker Ireland

Tel: +353 (0)21 432 3626
Fax: +353 (0)21 432 3623
Email: sales.ie@jameswalker.biz

James Walker Italiana

Tel: +39 02 257 8308
Fax: +39 02 263 00487
Email: sales.it@jameswalker.biz

James Walker Mfg (USA)

Tel: +1 708 754 4020
Fax: +1 708 754 4058
Email: sales.jwmfg.us@jameswalker.biz

James Walker New Zealand

Tel: +64 (0)9 272 1599
Fax: +64 (0)9 272 3061
Email: sales.nz@jameswalker.biz

James Walker Norge

Tel: +47 22 706800
Fax: +47 22 706801
Email: sales.no@jameswalker.biz

James Walker Oil & Gas (USA)

Tel: +1 281 875 0002
Fax: +1 281 875 0188
Email: oilandgas@jameswalker.biz

James Walker Singapore

Tel: +65 6777 9896
Fax: +65 6777 6102
Email: sales.sg@jameswalker.biz

James Walker South Africa

Tel: +27 (0)31 205 6251/2/3
Fax: +27 (0)31 205 6266
Email: sales.za@jameswalker.biz

James Walker & Co Ltd

Customer Support Centre
1 Millennium Gate, Westmere Drive
Crewe, Cheshire CW1 6AY, UK
Tel: +44 (0)1270 536000
Fax: +44 (0)1270 536100
Email: csc@jameswalker.biz

www.jameswalker.biz



CERTIFICATE No. FM 01269
BS EN 9100:2003
BS EN ISO 9001:2008